

TECHNICAL CATALOGUE

VEKA

MADE PERFECT. STAYS PERFECT.



SQR

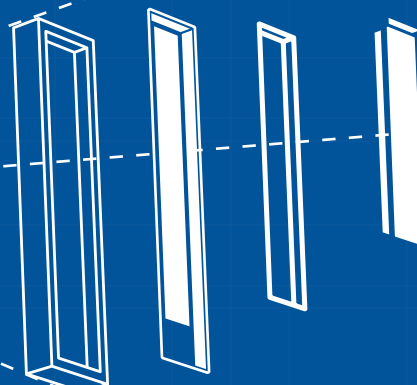
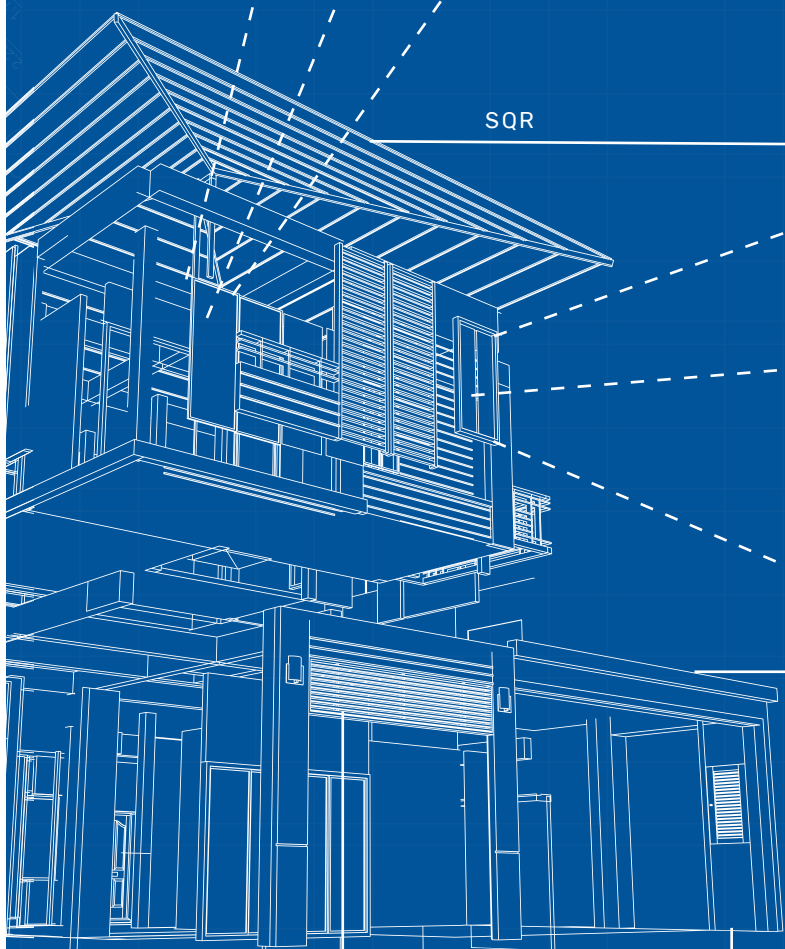

12x

3M



TWO LEADERS. ONE GREAT PARTNERSHIP.

NCL VEKA is a joint venture between NCL, India and VEKA, Germany. The two behemoths have a combined experience of 90 years in window manufacturing.

NCL VEKA has a capacity to manufacture 20,000 tonnes of profiles every year which can approximately meet the requirements of 3,50,000 homes. While NCL has the largest network of dedicated fabricators in the country, VEKA AG is the largest uPVC manufacturer in the world with presence across 40 countries.

The coming together of the two giants means that the products not just conform to the European standards, but is also best suited for Indian conditions.



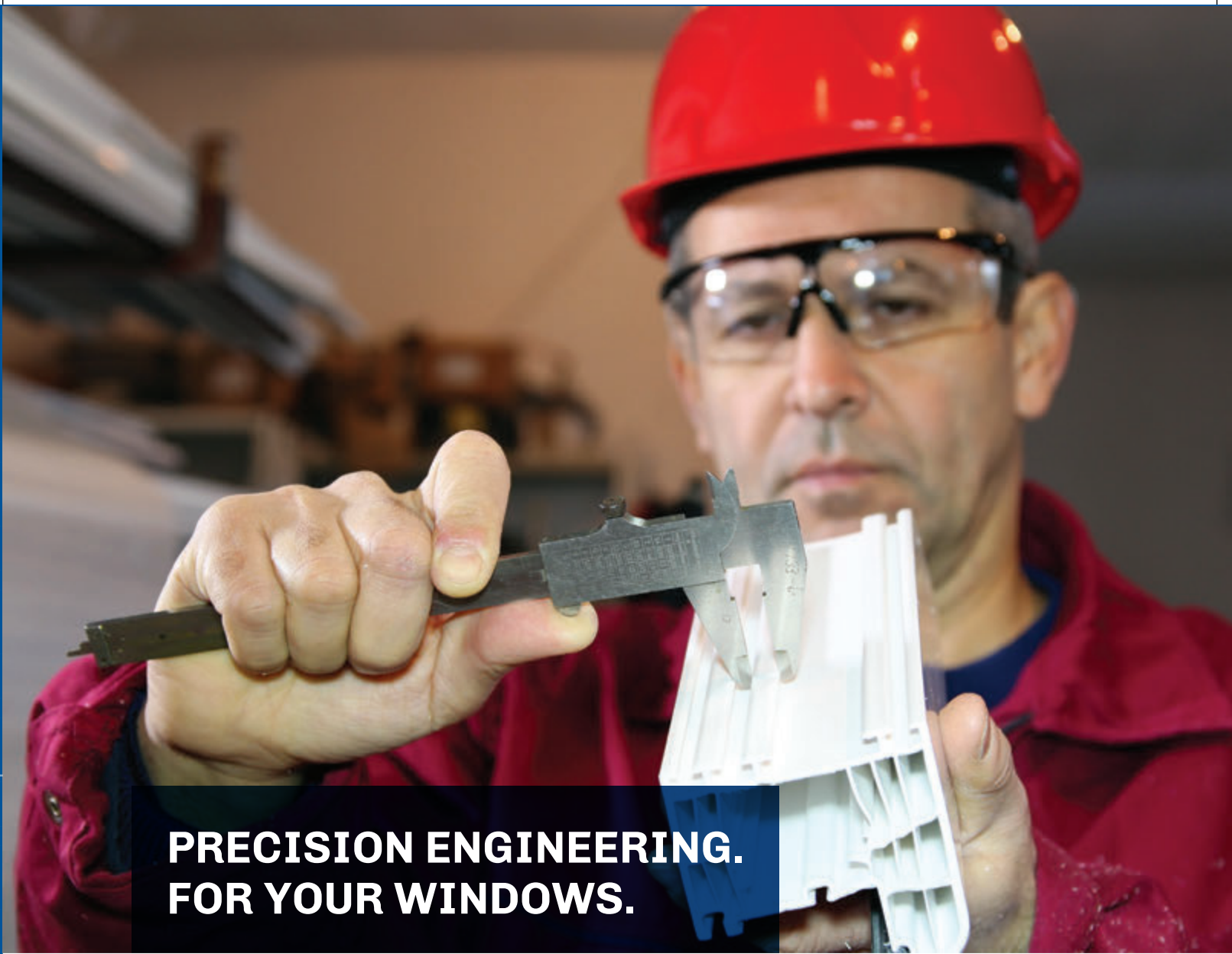

PRECISION ENGINEERING. FOR YOUR WINDOWS.

Windows are a permanent fixture in your happiness. How about sharing this piece of joy with generations to come? At **NCL VEKA**, we don't just put windows together, but we engineer them to be perfect. With an attention to details that border on obsession, we craft the windows with utmost precision. So that it shows even decades later.

Every time you touch it, or even look at it, you experience the magnificence of German engineering at work. It's either perfect, or it is not. With NCL VEKA, it's never not.





CERTIFICATIONS

VEKA windows have been tested for its physical properties and its lead content. They conform to the quality standards approved by the major accreditation councils.



Profile test report

A framed document titled "SGS" with a table of test results. The table has columns for "Reference No.", "Date", "Method", "Lot No.", "Page", and "Date". It lists various test results for lead content, showing values like "0.000000" and "0.000000". The document is signed and stamped at the bottom.

Lead free test report



Casement window test report



Sliding window test report

I - 60 CASEMENT SERIES

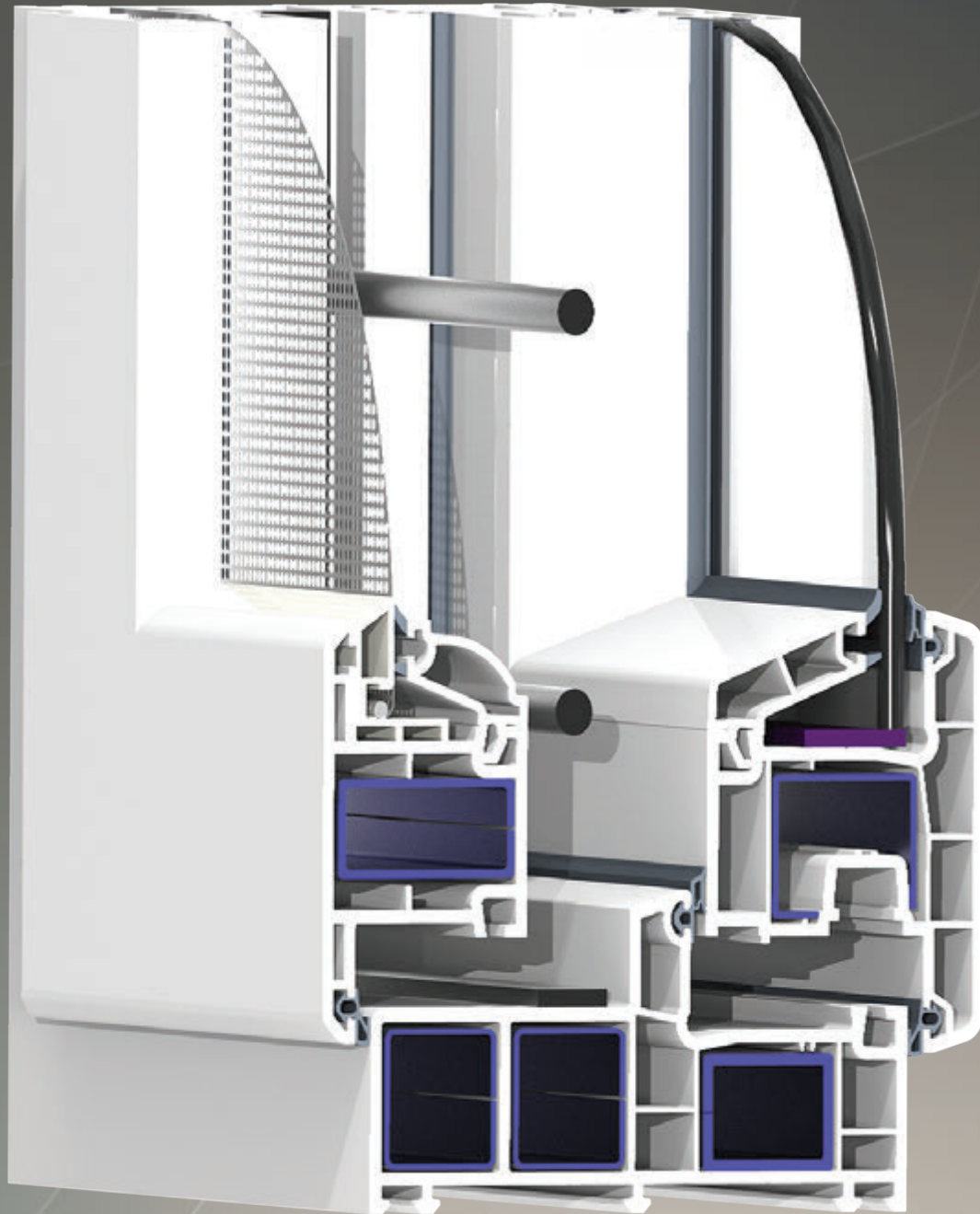

LAMINATION COLOURS

Standard:



Mahogany



Rustic Oak



Golden Oak



Grey



Walnut



Black

PROFILES

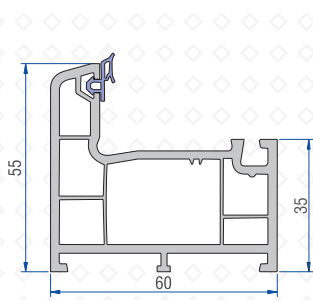

Frame Profile
41101-11000

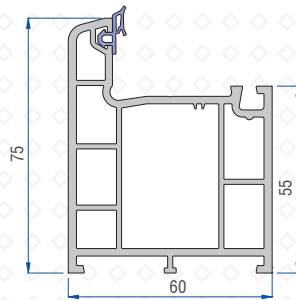

Super Frame Profile
41101-19000

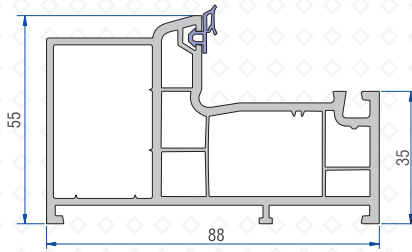

Frame with Grill
41101-16000

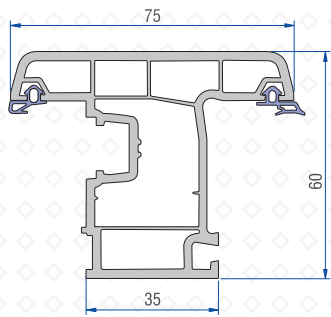

Window Sash Profile
41101-13000

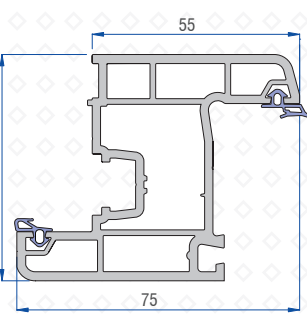

Inward Opening Sash Profile
41101-13100

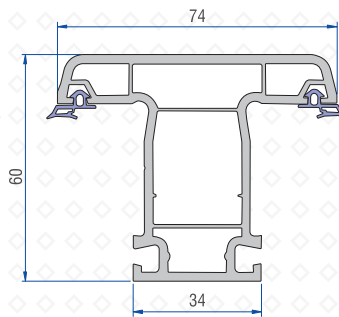

Mullion Profile
41101-12000

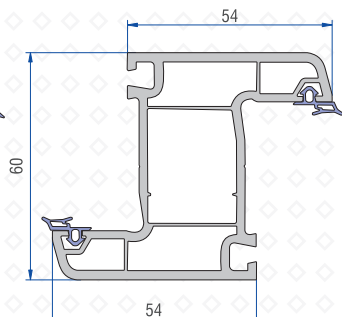

Outward Opening Mullion Profile
41101-12100

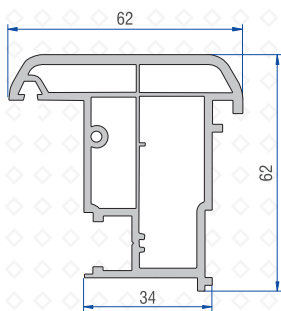

Lap Joint Profile
41101-15000

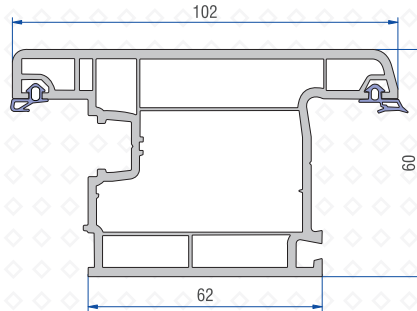

Door Sash Profile
41101-14000

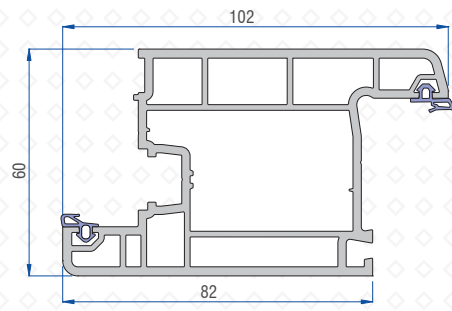

Inward Opening Door Sash Profile
41101-14100

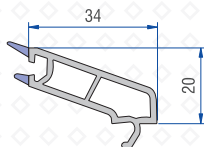

Single Glazing Bead (6mm)
40101-03300

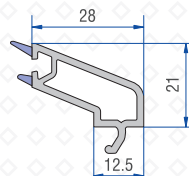

Single Glazing Bead (12mm)
40101-03200

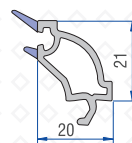

Double Glazing Bead (20mm)
40101-03400

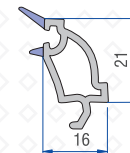

Double Glazing Bead (24mm)
40101-03500

PROFILES

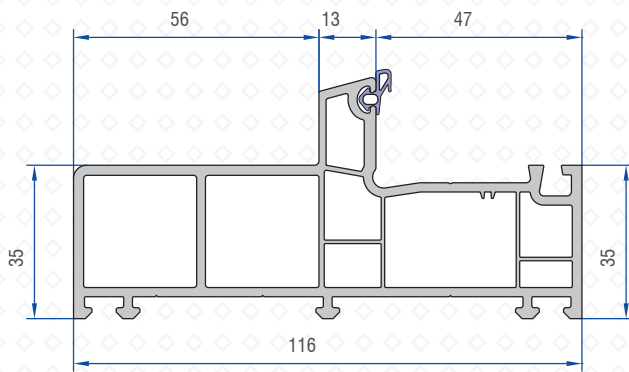

Frame with Grill & Mesh
41101-16100

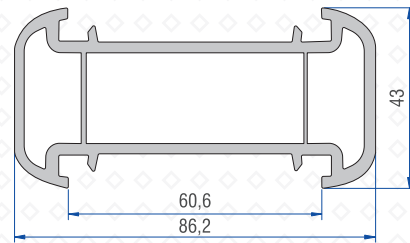

Large Coupling Profile
40107-01200

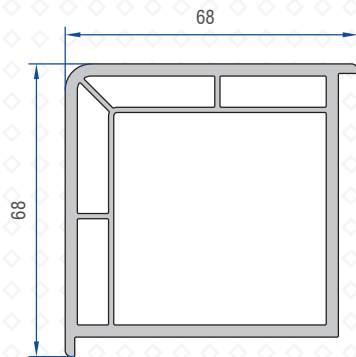

Corner Profile (90°)
2108-3101

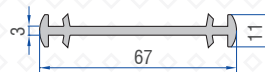

Mini Coupling / Coupling Profile
2108-3108

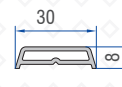

Georgian Bar
2108-3105

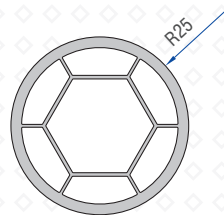

Bay Pole / Pipe Profile
2108-3103

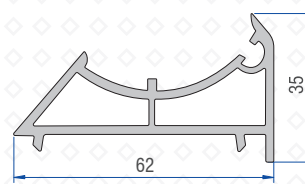

Bay Pole Adaptor / Pipe Adaptor Profile
2108-3104

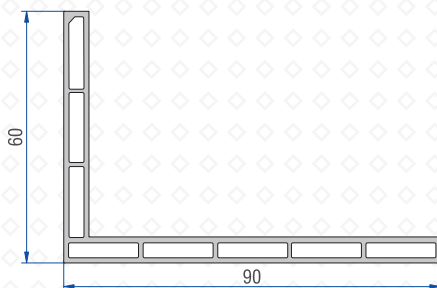

Border Profile
40110-02000

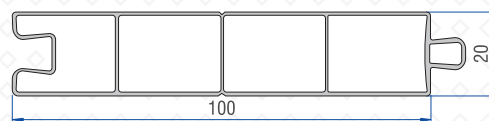

Panel Profile (100 x 20)
40108-08000

ALUMINIUM PROFILES

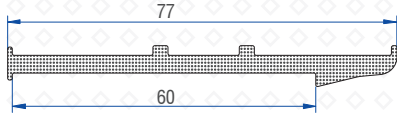

I-75 to I-60 Frame Coupler (Alm)
50502-11036

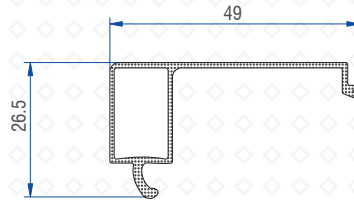

Fixed Louver Clip (Alm)
50502-11038

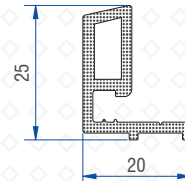

Mesh Adaptor (Alm)
540502-11041

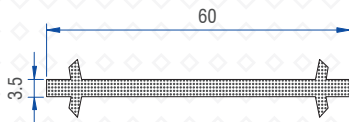

Coupling Profile (Alm)
50502-11043

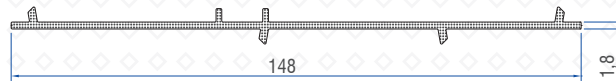

Grill & Mesh to Frame with Grill Coupler (Alm)
50502-11074

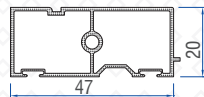

Casement door sash infill (Alm)
50502-11070

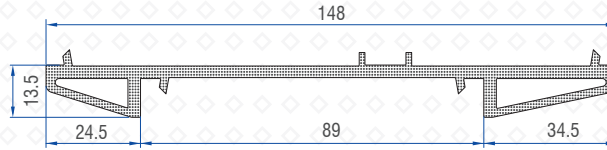

Coupler for Mesh and Grill Frame (Alm)
50502-11046

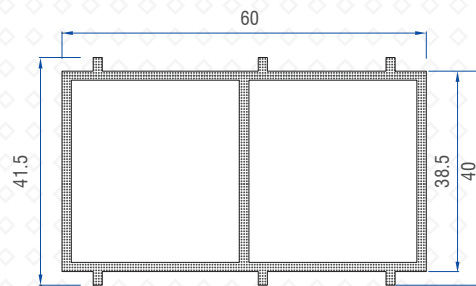

Casement Sub Frame
50502-11068

GA DRAWINGS - CASEMENT DOOR

CASEMENT DOOR WITH MULLION

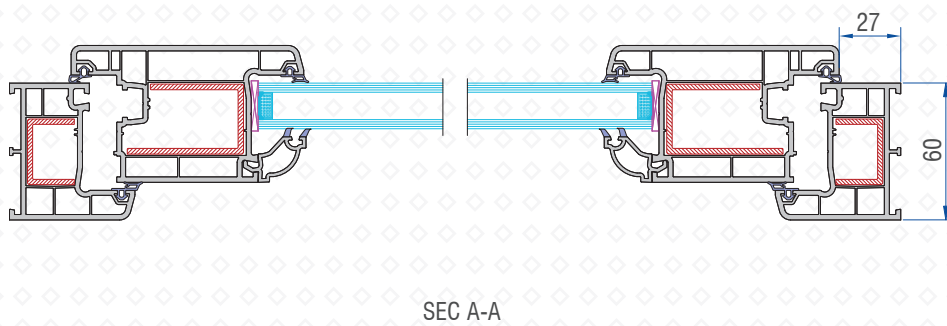
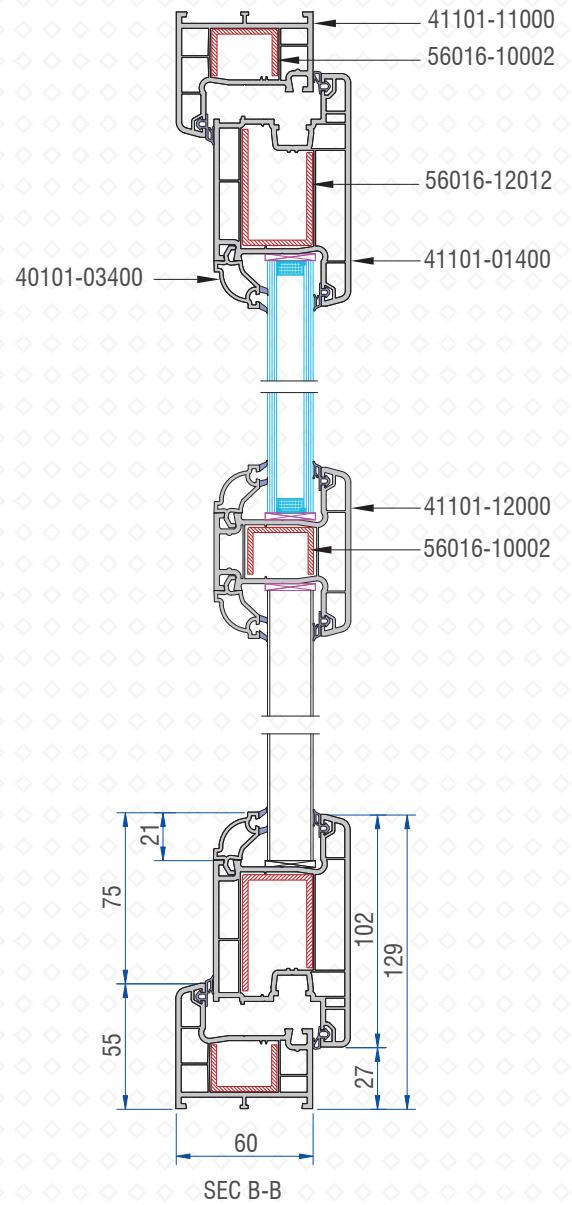
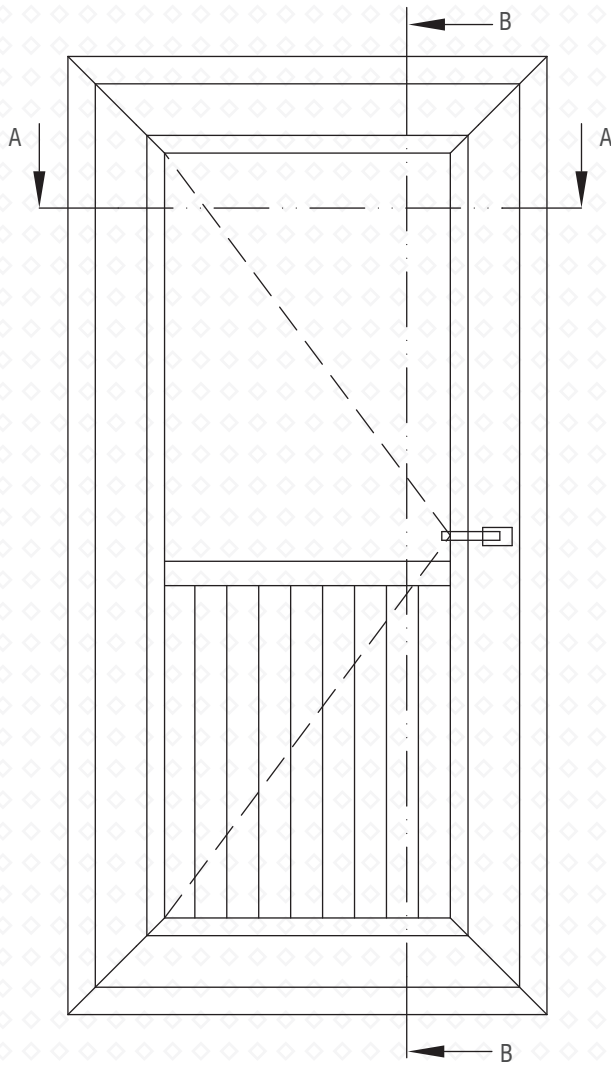

GA DRAWINGS - CASEMENT WINDOW

DOUBLE SASH CASEMENT WINDOW

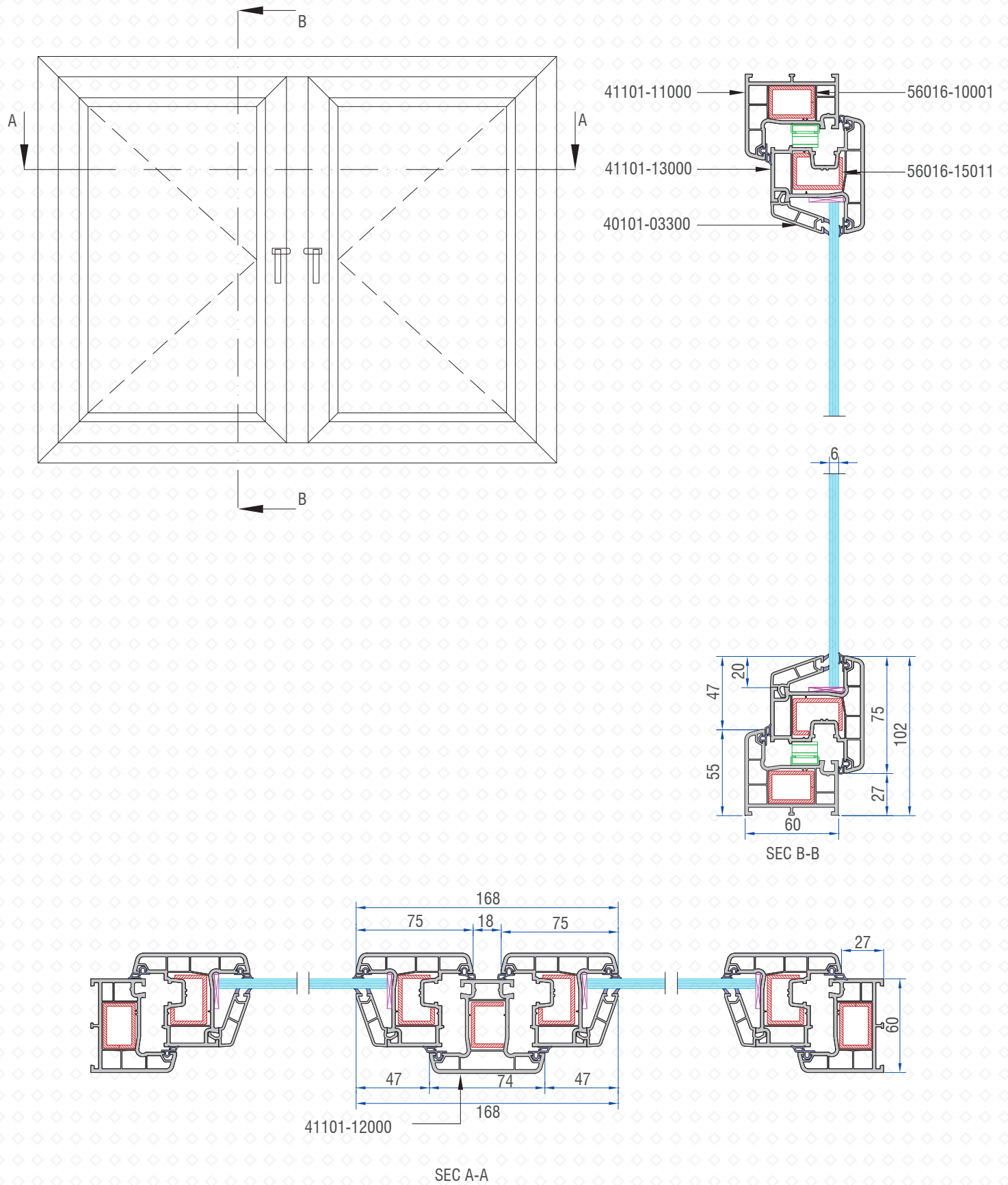

GA DRAWINGS - CASEMENT WINDOW

DOUBLE SASH CASEMENT WINDOW WITH MESH AND GRILL

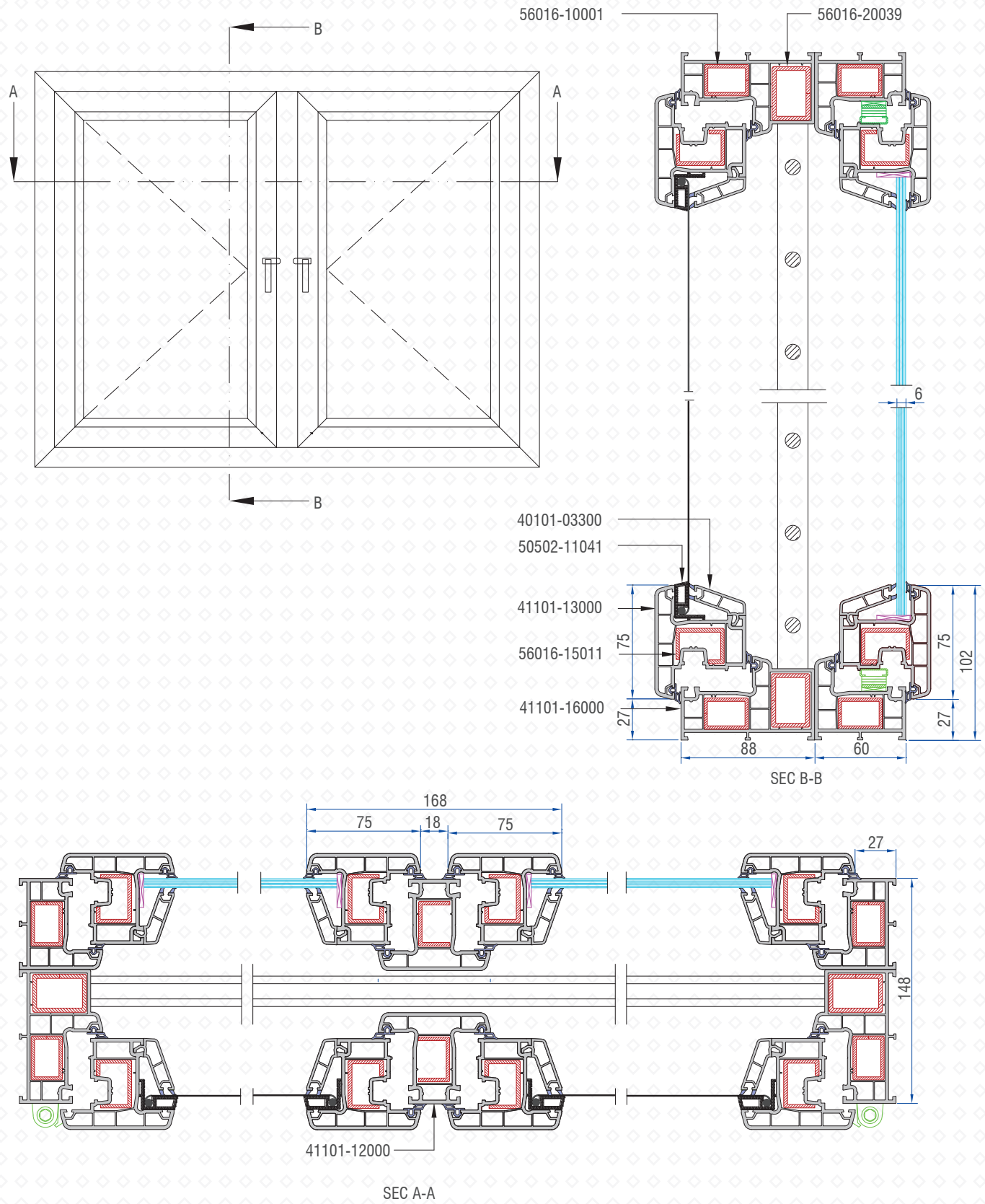

GA DRAWINGS - CASEMENT WINDOW

DOUBLE SASH CASEMENT WINDOW WITH MESH AND GRILL

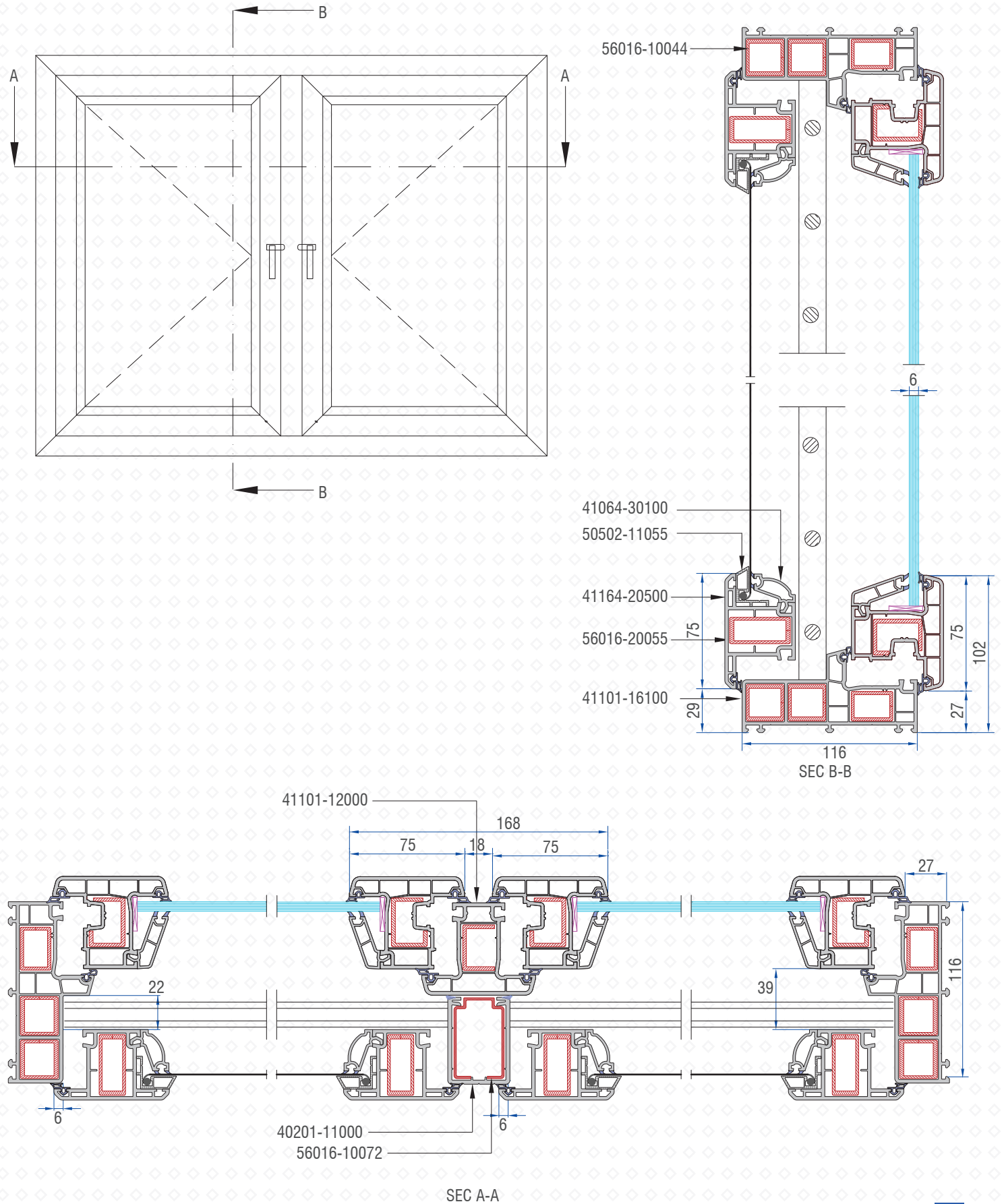

SECTIONAL DRAWINGS - CASEMENT WINDOW

CASEMENT WINDOW WITH FIXED PANEL

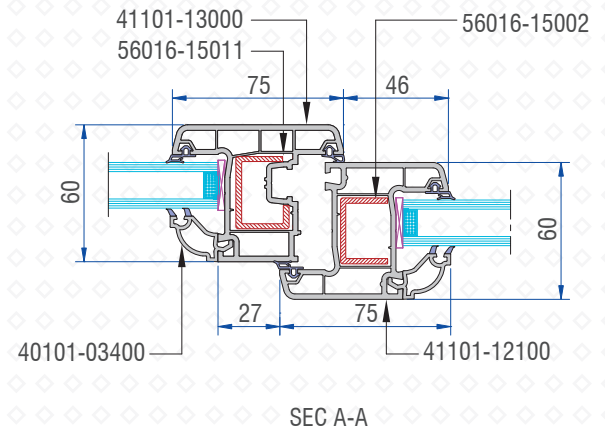
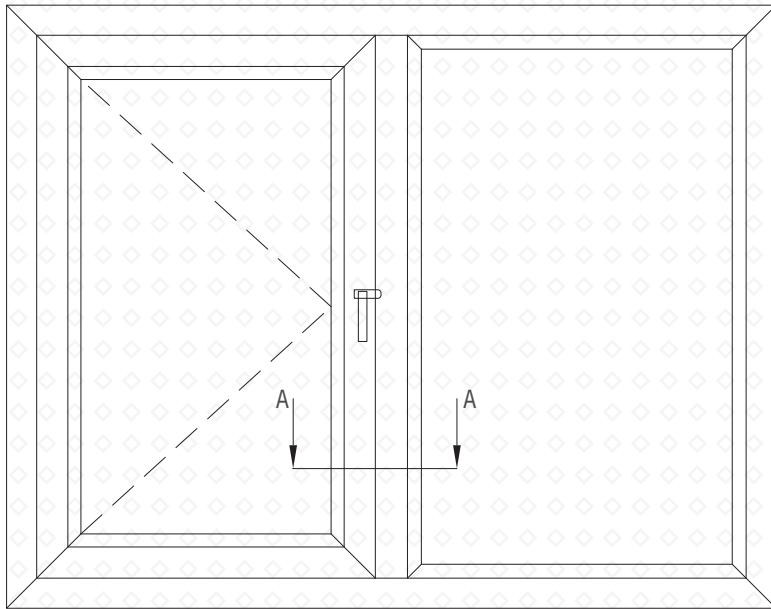

CASEMENT WINDOW WITH LAP JOINT

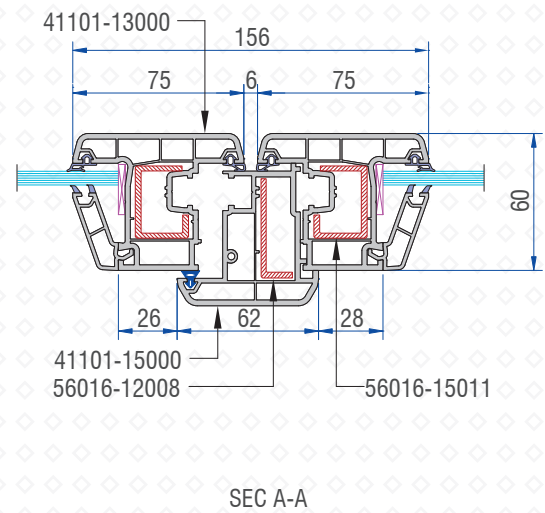
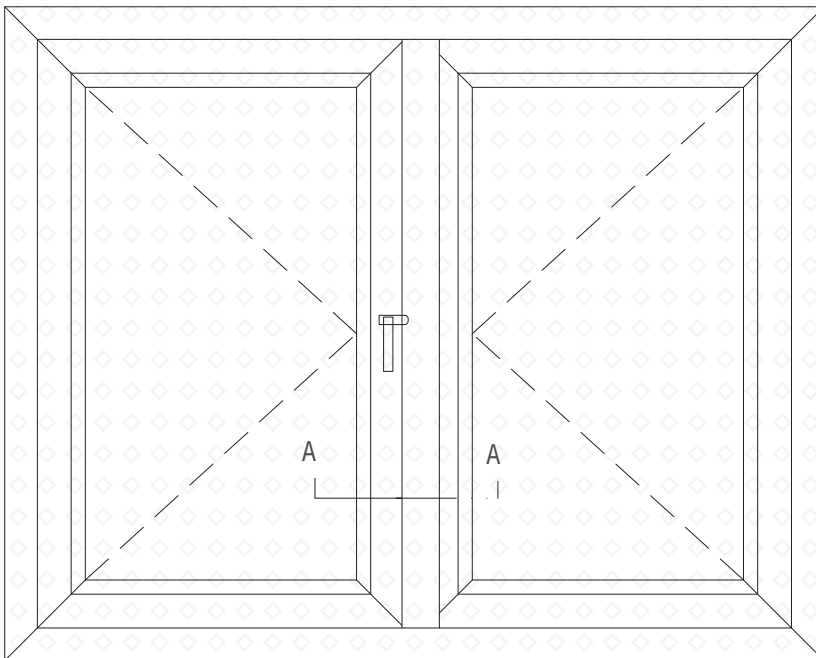

I - 50 SLIDING SERIES



PROFILES

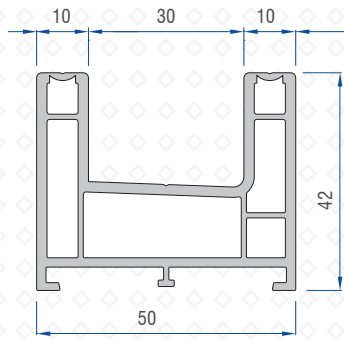

Double Rail Profile
40502-11000

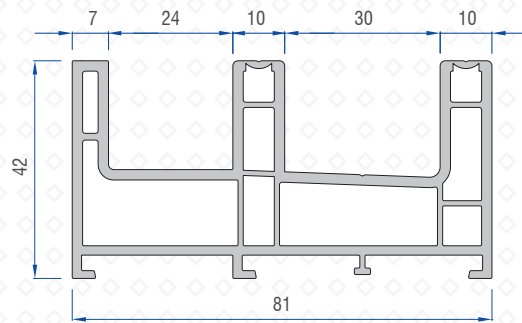

Double Rail with Screen Track Profile
40502-12000

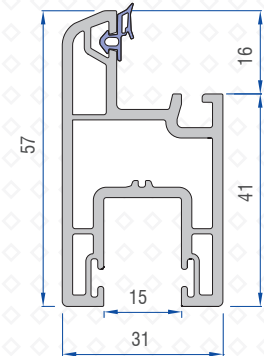

Sash Profile
40502-13000

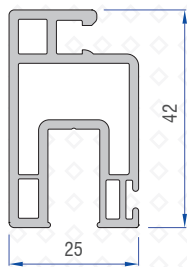

Screen Sash Profile
41301-05200

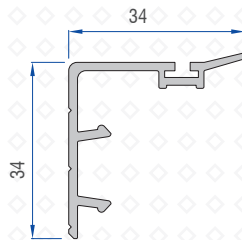

Sash Cover Profile
40502-13100

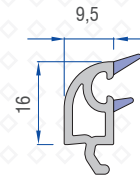

Single Glazing Bead
40502-14000

Aluminium Profiles

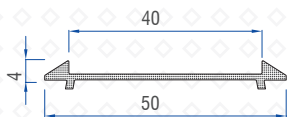

Frame Coupler I-50(2T) to I-39
50502-11066



Flat Rail Profile(Alm)
50502-11013

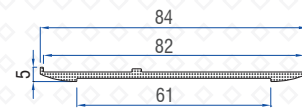

I-50(2.5T)/I-60 Frame Coupler
50502-11062

GA DRAWINGS - SLIDING WINDOW

2 TRACK 2 PANEL WINDOW

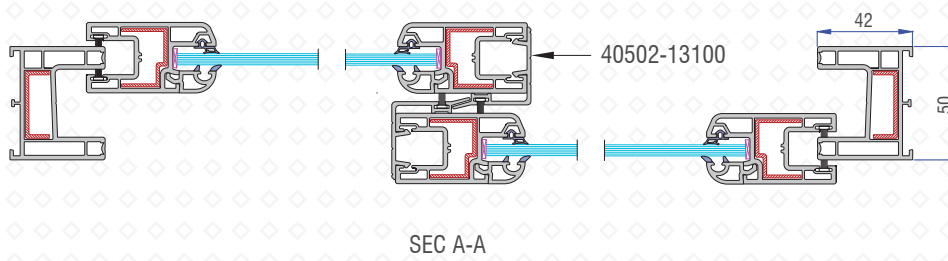
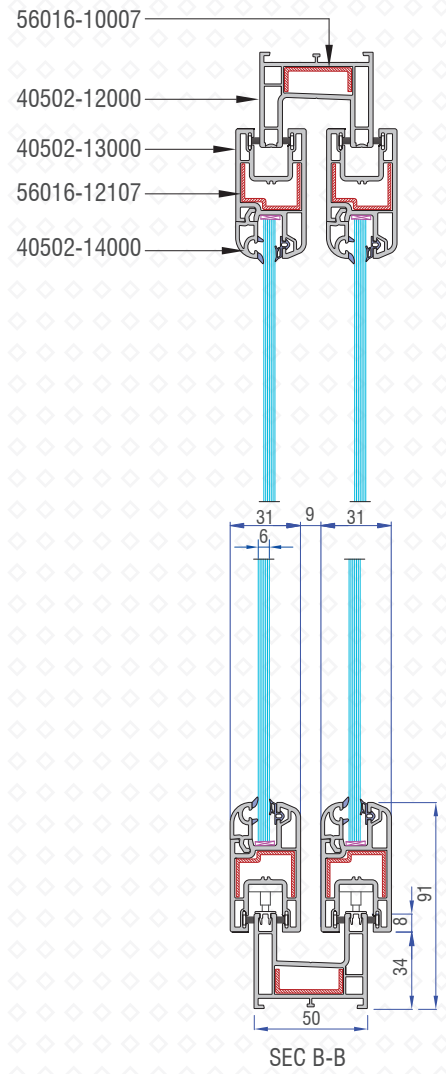
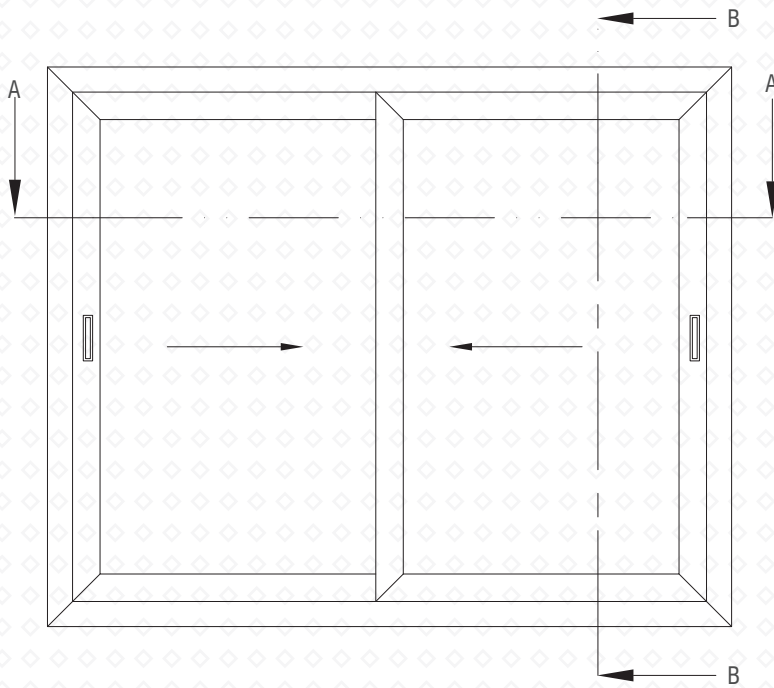

GA DRAWINGS - SLIDING WINDOW

2.5 TRACK 2 PANEL WITH MESH

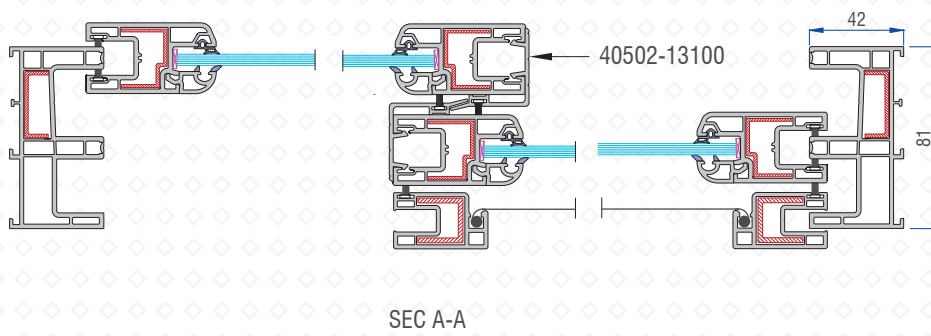
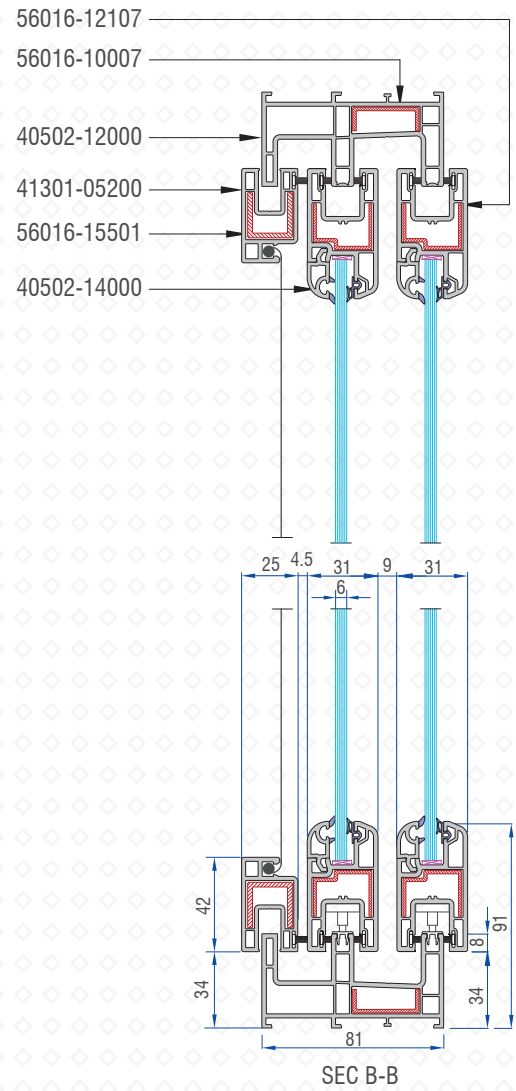
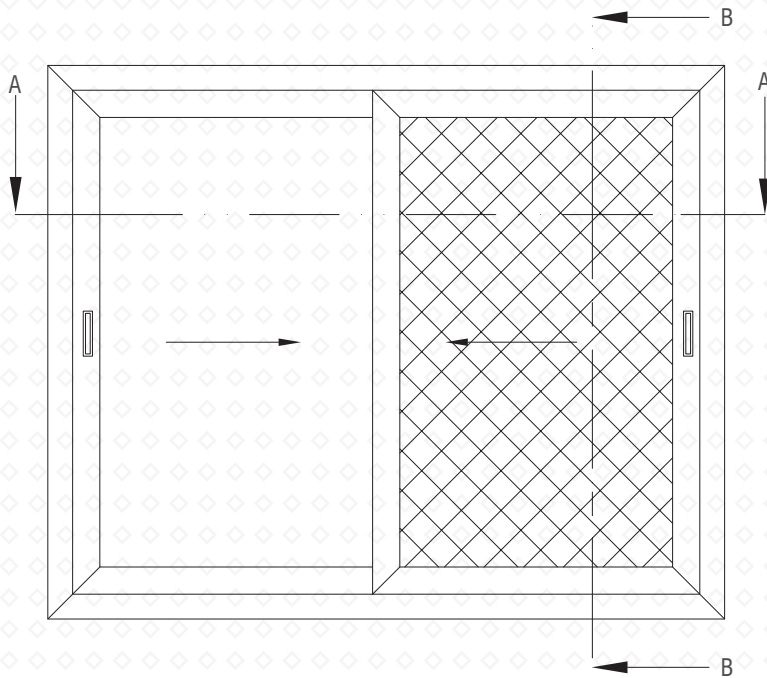

I - 60 SLIDING SERIES

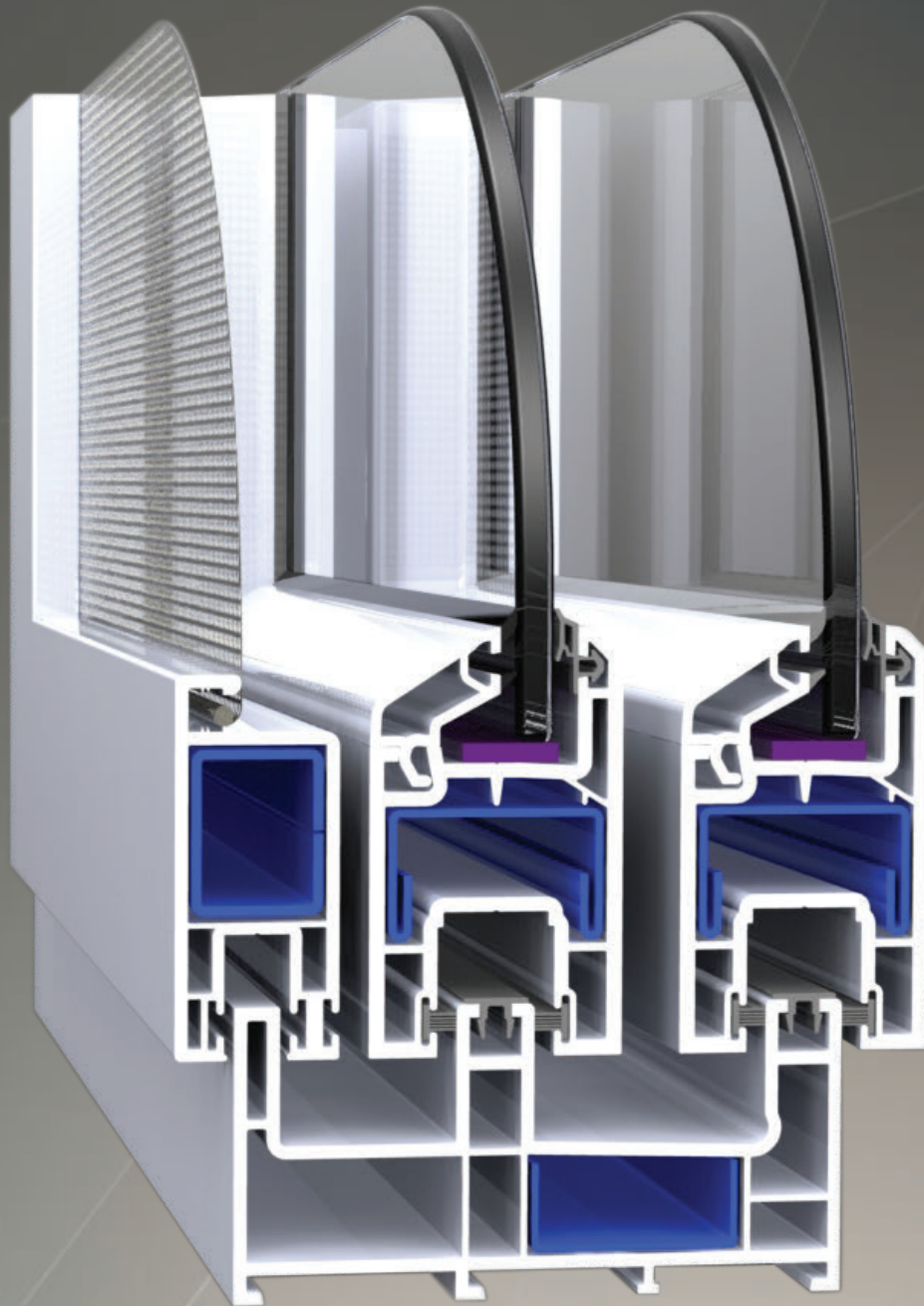

LAMINATION COLOURS

Standard:



Mahogany



Rustic Oak



Golden Oak



Grey



Walnut



Black

PROFILES

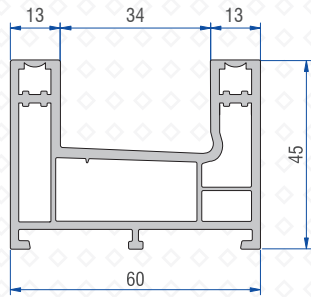

Double Rail Profile
41201-12000

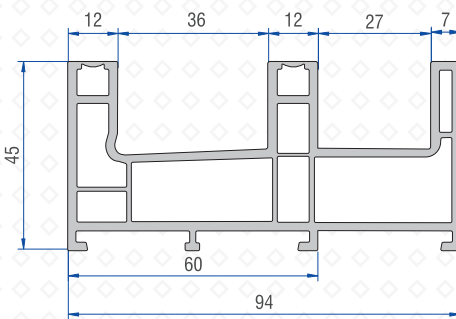

Double Rail with Screen Track Profile
41201-05100

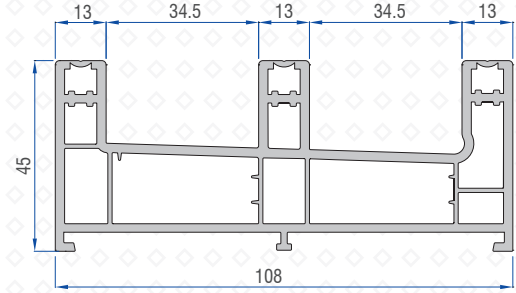

Triple Rail Profile
41201-15000

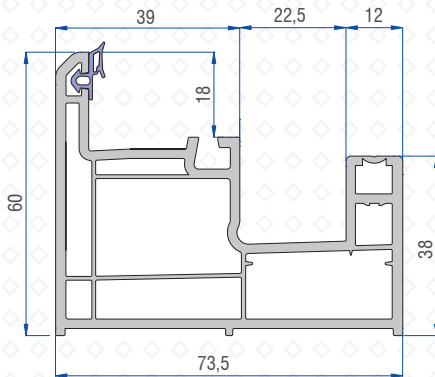

Mono Rail Profile
41201-08000

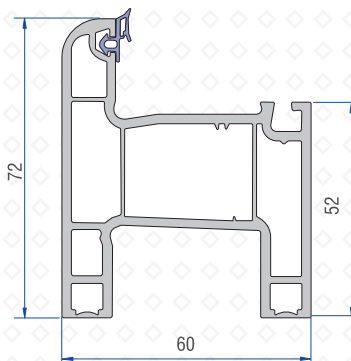

Casement - Sliding Mullion Profile
41201-14100

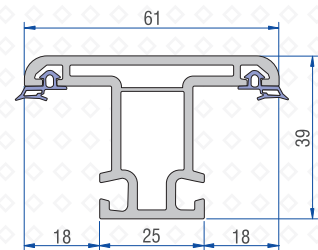

Mullion Profile
41201-04000

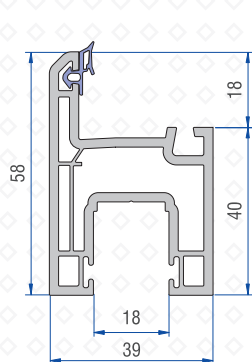

Sash Profile
41201-03300

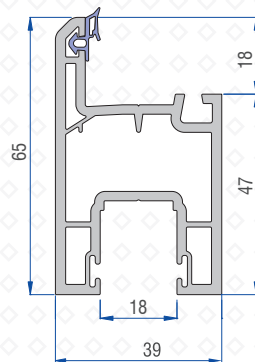

65mm Sash Profile
41201-03200

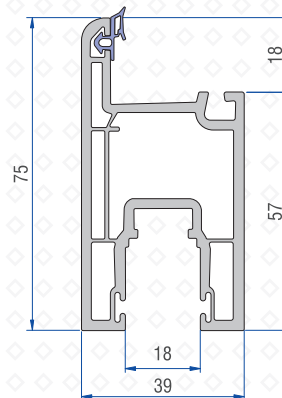

Super Sash Profile
41201-03000

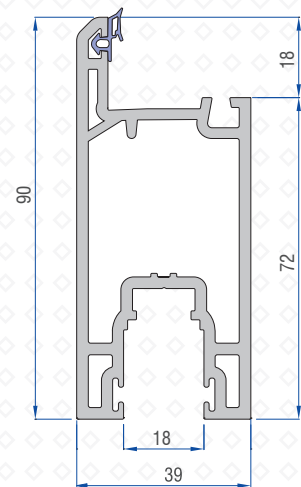

Mega Sash Profile
41201-07000

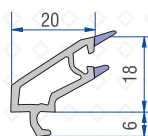

Single Glazing Bead (6mm)
40101-04400

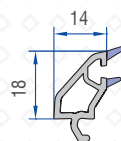

Single Glazing Bead (12mm)
40101-04600

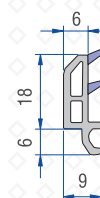

Double Glazing Bead (20mm)
40101-04500

PROFILES

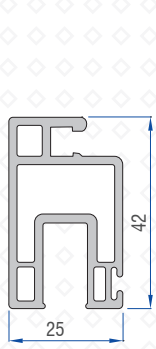

Screen Sash Profile
41301-05200

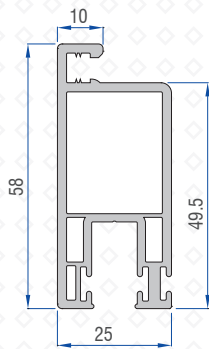

Mega Screen Sash Profile
41201-05300

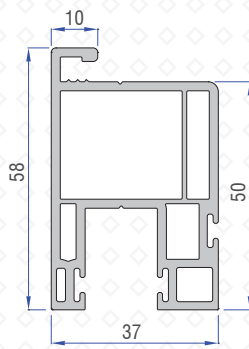

Super screen sash (New)
41221-03000

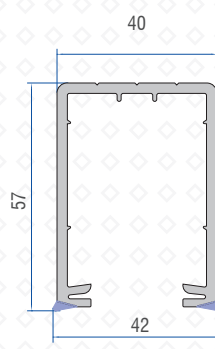

Stiffener Profile /
Hurricane Bar Profile
40201-11000

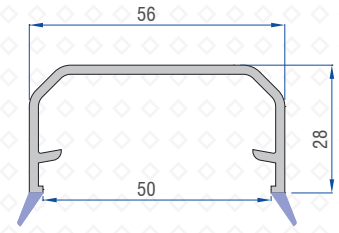

Hurricane Bar Profile
40201-01000

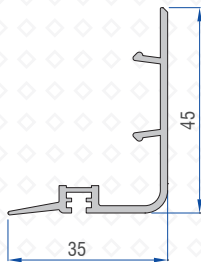

Sash Cover Profile
41201-06100

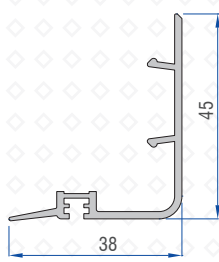

65mm Sash Cover Profile
41201-06200

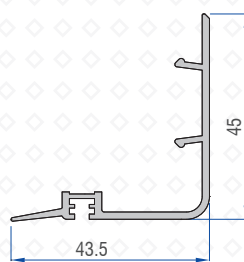

Super Sash Cover Profile
41201-06000

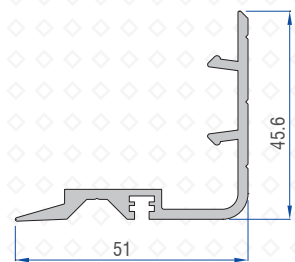

Mega Sash Cover Profile
41201-06300

Aluminium Profiles

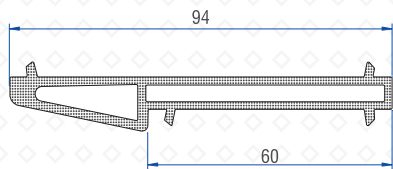

Casement - Sliding Profile Coupler (Alm)
50502-11039

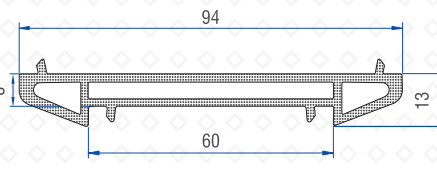

Casement - Sliding Profile Middle Coupler (Alm)
50502-11040

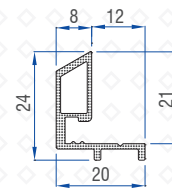

Mesh Adaptor (Alm)
50502-11055



Rail Profile (Alm)
50502-11011

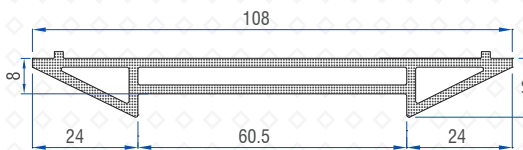

New 3-Track Coupler (Alm)
50502-11057

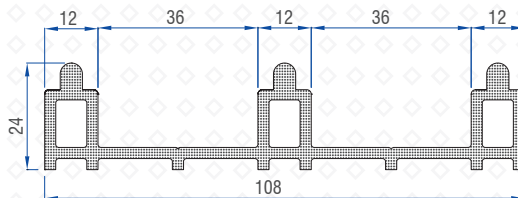

3-Track Low Threshold (Alm)
50502-11047

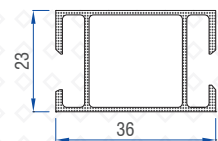

Multi Track Adaptor (Alm)
50502-11017

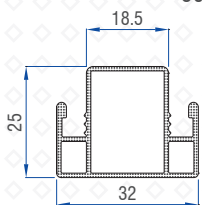

Screen Sash Mullion (Alm)
50502-11037

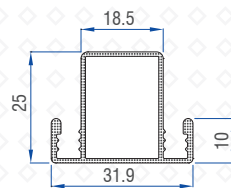

Mega Screen Sash Mullion-2.5T (Alm)
50502-11058

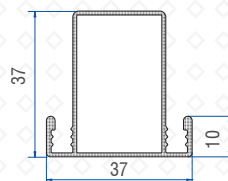

Super Screen Sash Mullion-3T
50502-11077

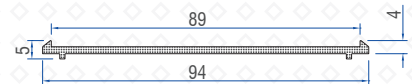

Casement Sliding Middle
Coupler 2.5T (I-60)
50502-11073

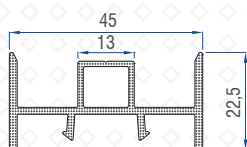

Inline Sash Adaptor (Alm)
50502-11060

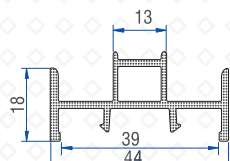

Inline Sash Adaptor (Alm)
50502-11034

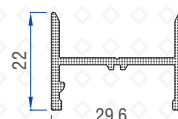

Adaptor for Screen Sash-2.5T (Alm)
50502-11048

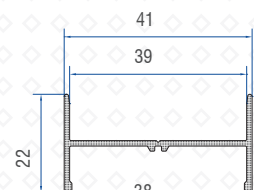

Adaptor for Super Screen Sash (New)
50502-11078

GA DRAWINGS - SLIDING WINDOW

2 TRACK 2 PANEL WINDOW

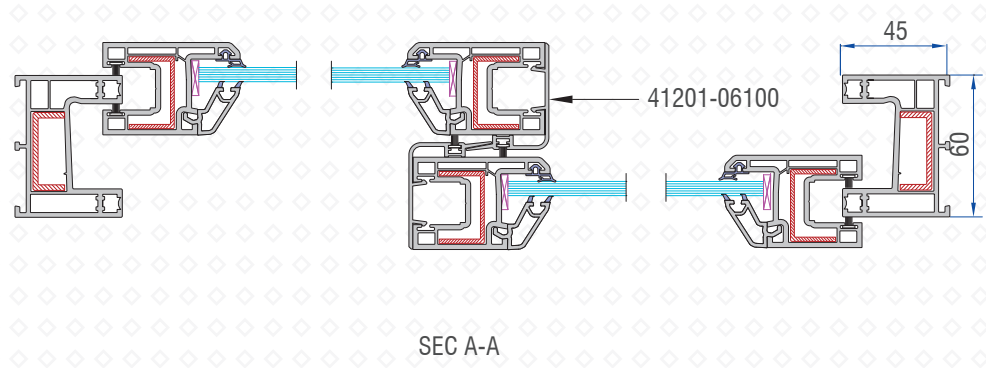
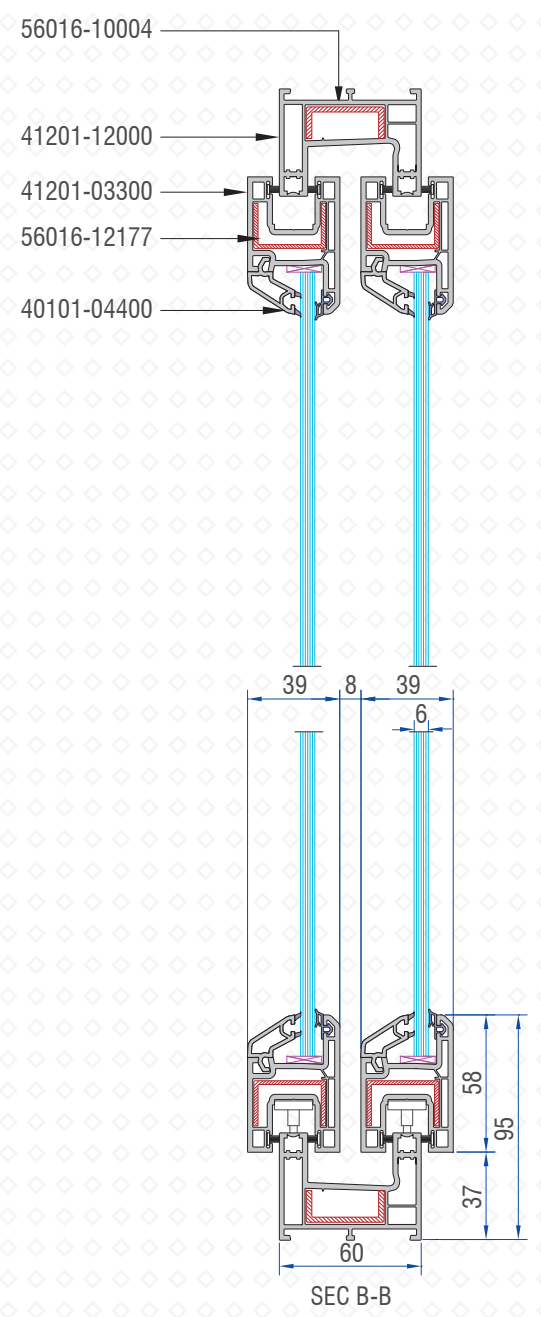
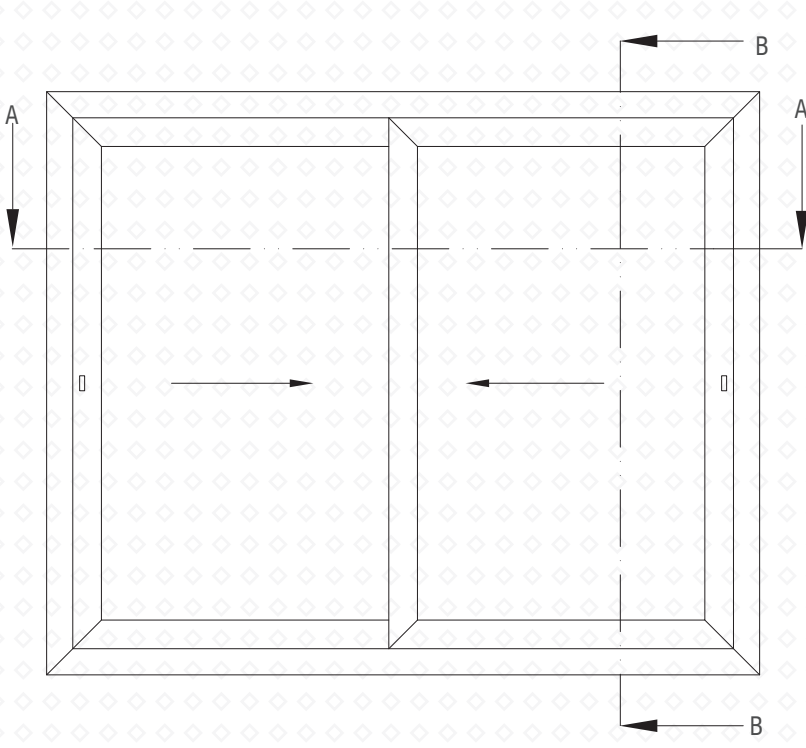

GA DRAWINGS - SLIDING WINDOW

2.5 TRACK 2 PANEL WITH MESH

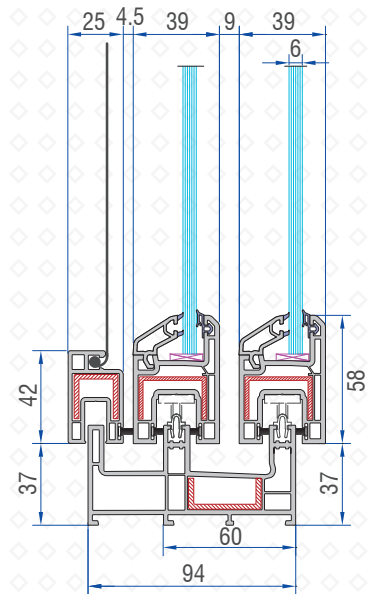
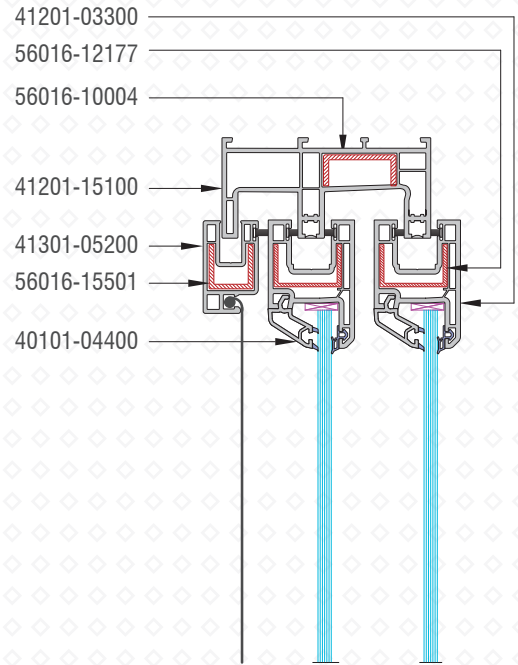
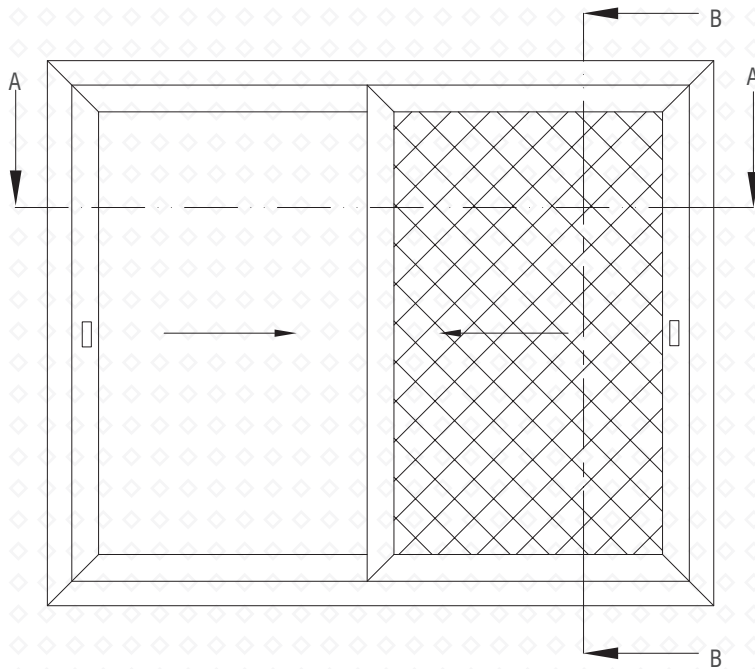

SEC B-B

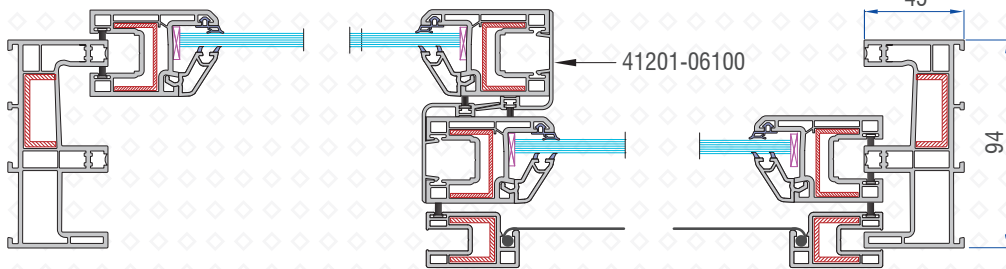

SEC A-A

GA DRAWINGS - SLIDING WINDOW

2.5 TRACK 2 PANEL WITH MESH

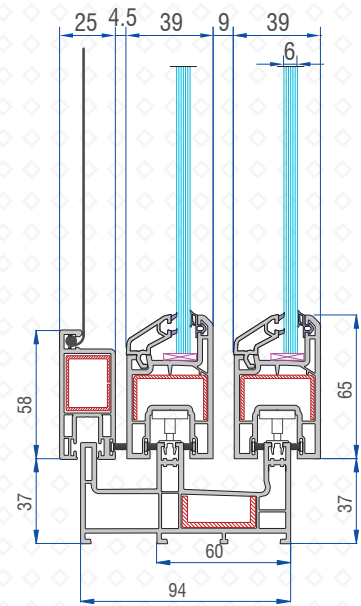
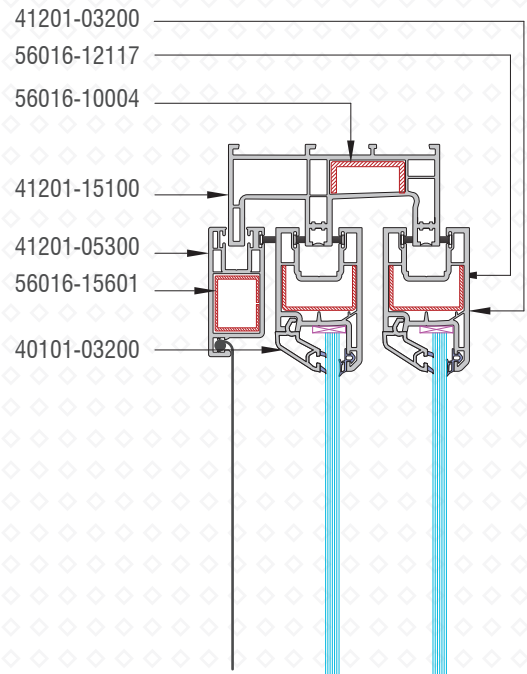
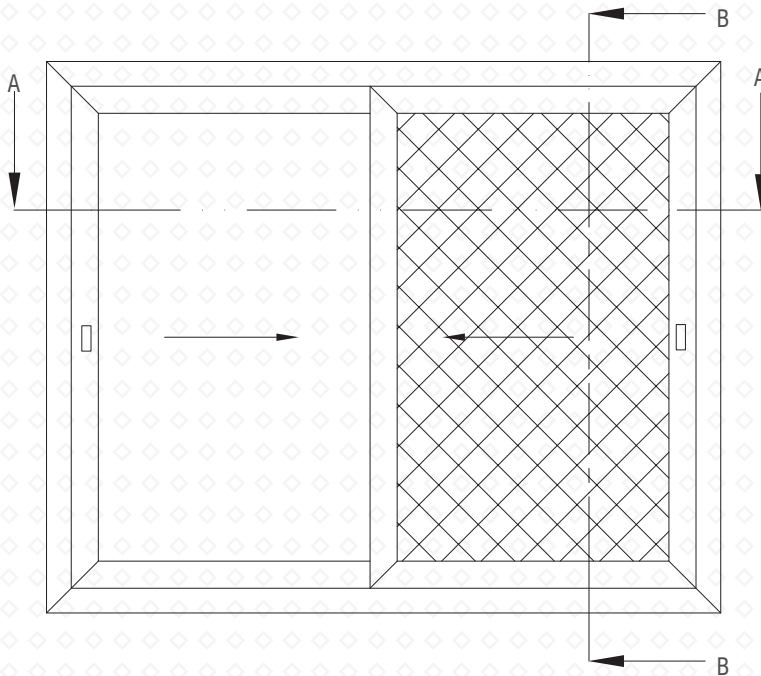

SEC B-B

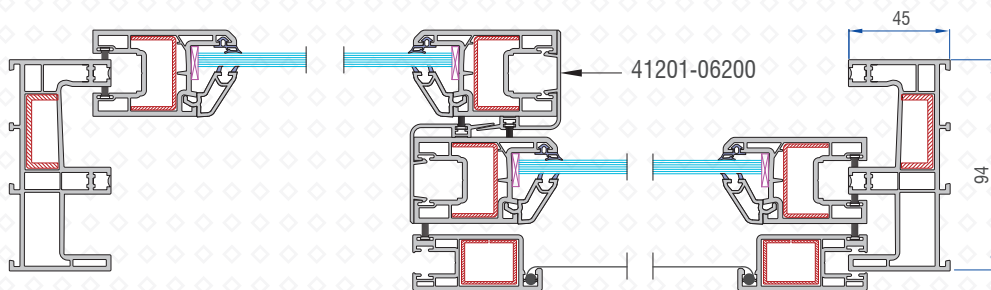

GA DRAWINGS - SLIDING DOOR

3 TRACK 3 PANEL DOOR

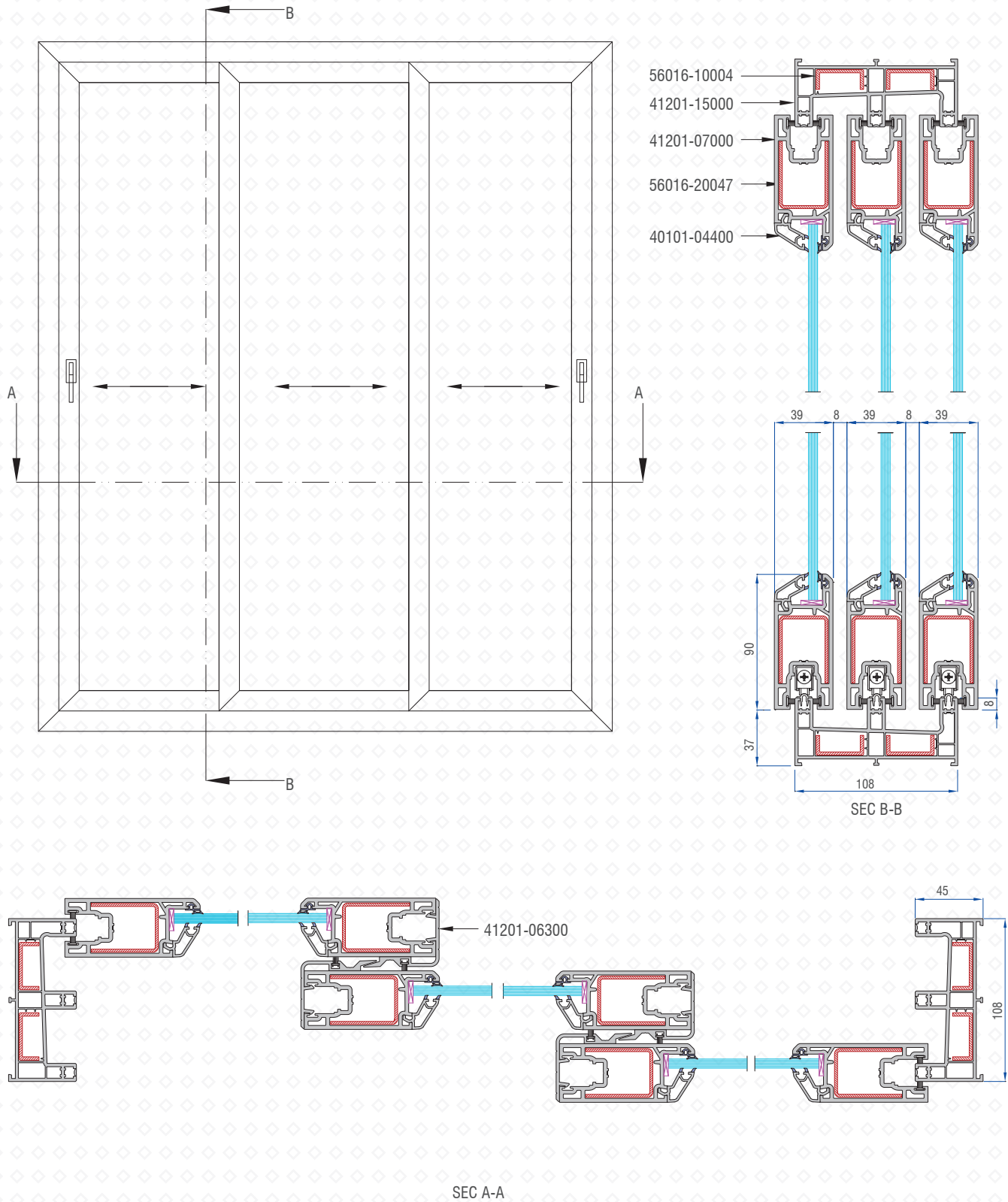

Note: Secondary reinforcement(56016-15057) is for high windload applications.

GA DRAWINGS - SLIDING DOOR

3 TRACK 2 PANEL AND MESH

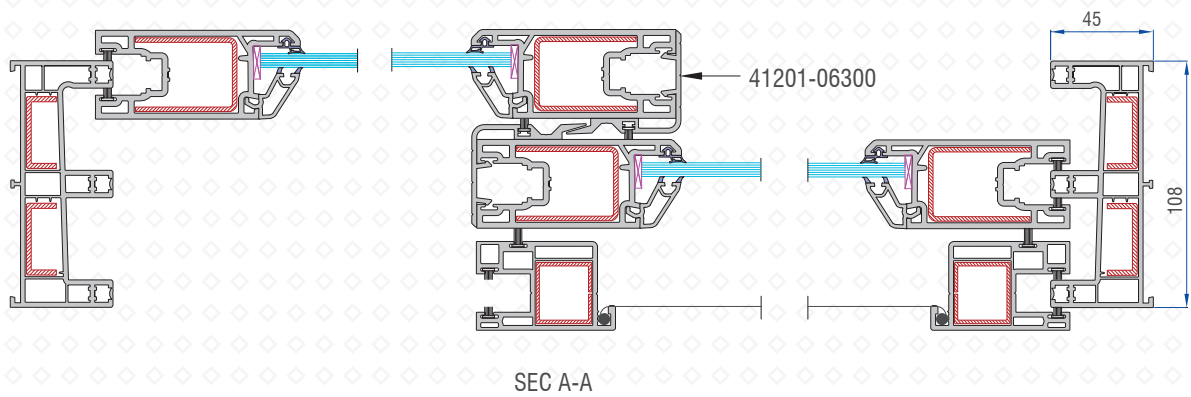
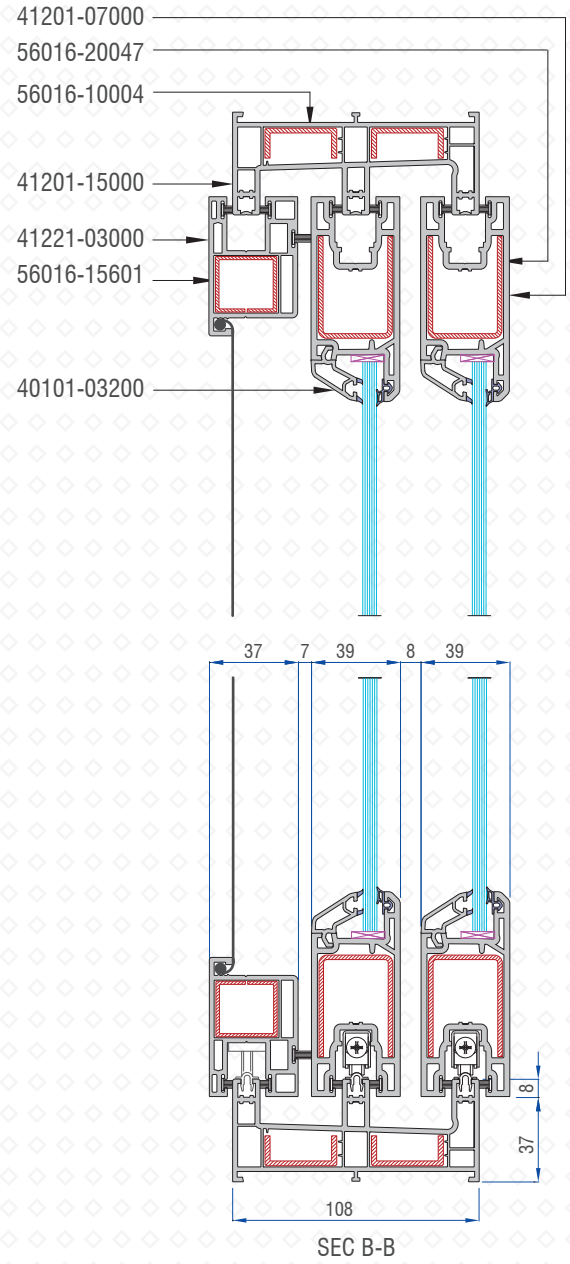
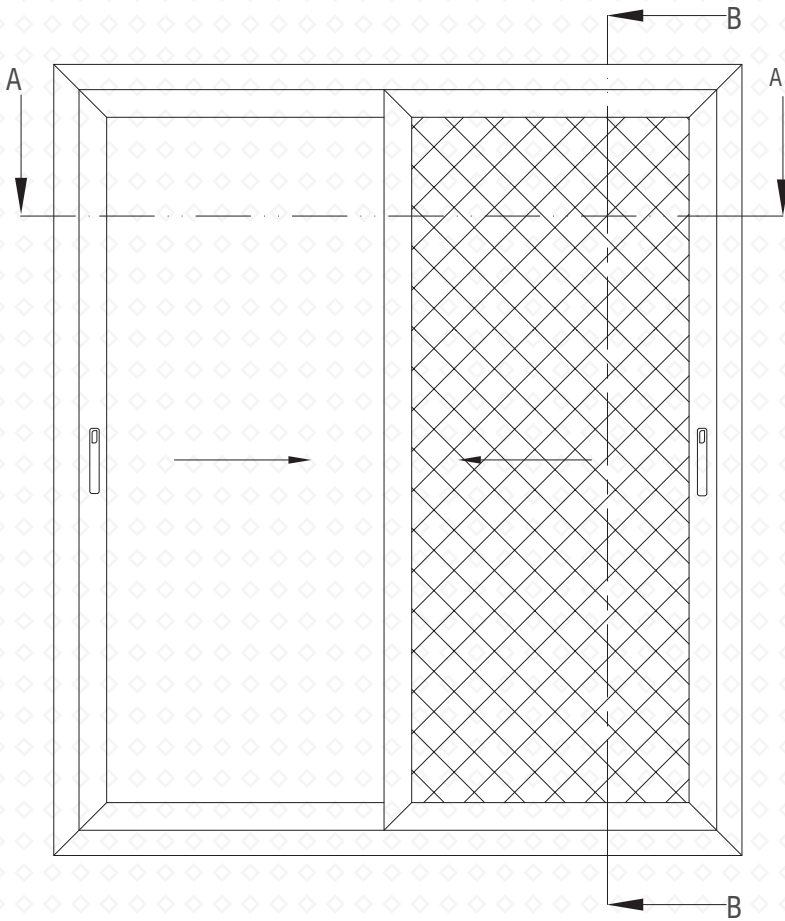

GA DRAWINGS - SLIDING WINDOW

MONOSLIDE WINDOW

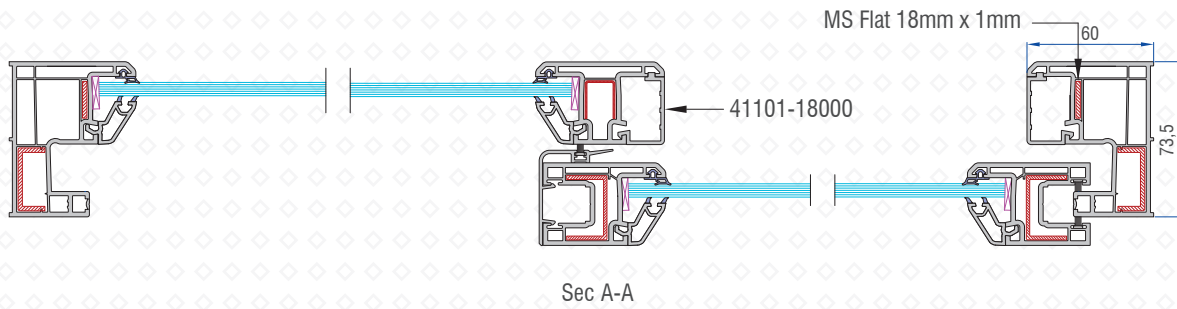
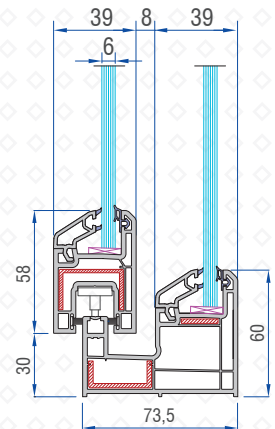
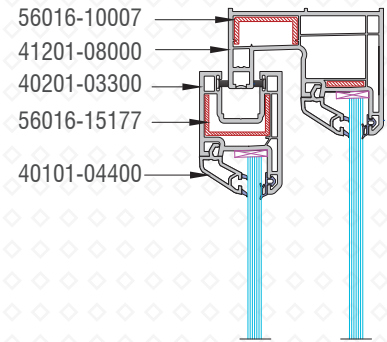
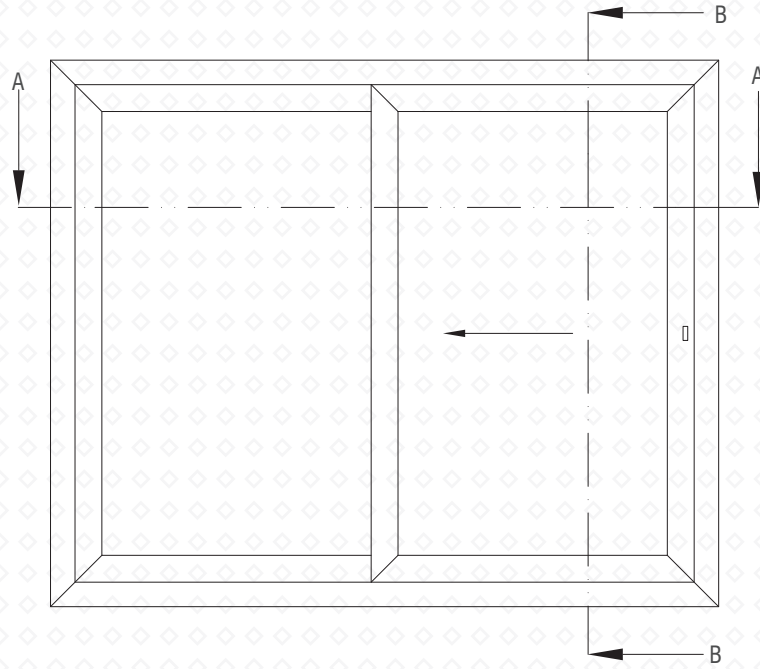

I - 64 SLIDING SERIES



LAMINATION COLOURS

Standard:



Mahogany



Rustic Oak



Golden Oak



Grey



Walnut



Black

PROFILES

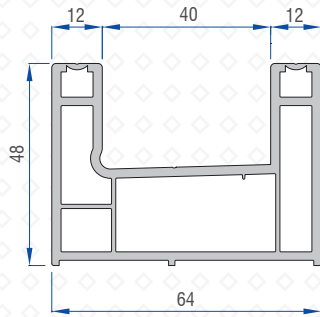

Double Rail Profile
41164-10100

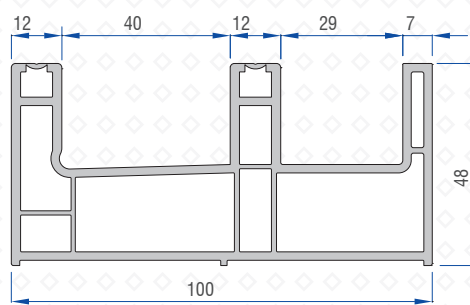

Double Rail with Screen Track Profile
41164-10200

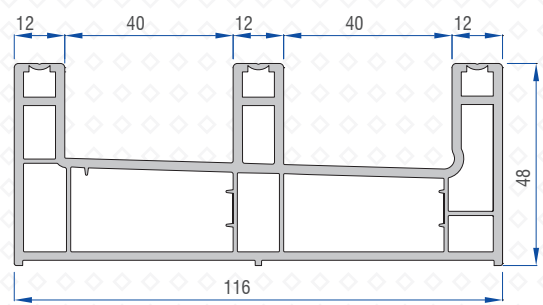

Triple Rail Profile
41264-10300

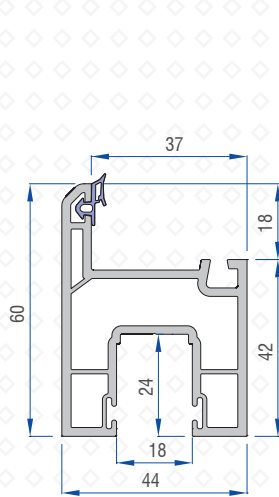

Sash Profile
41164-20100

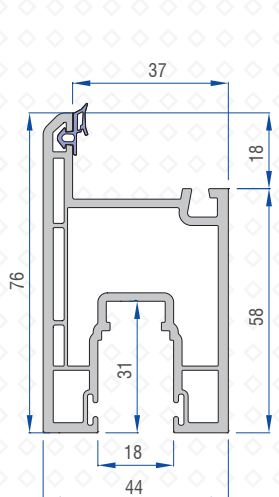

Super Sash Profile
41164-20300

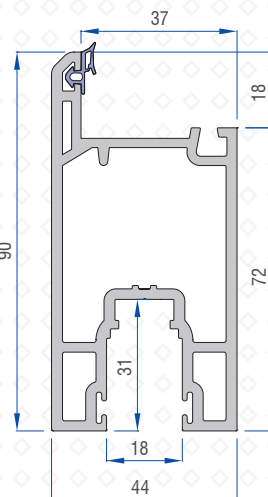

Mega Sash Profile
41264-20400

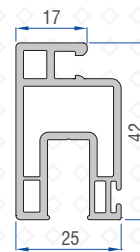

Screen Sash Profile
41301-05200

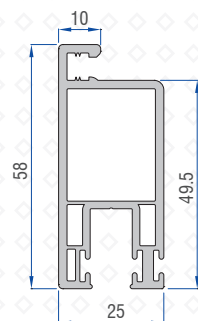

Mega Screen Sash Profile
41201-05300

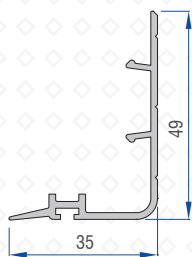

Sash Cover Profile
41064-40100

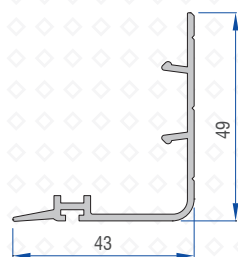

Super Sash Cover Profile
41064-40200

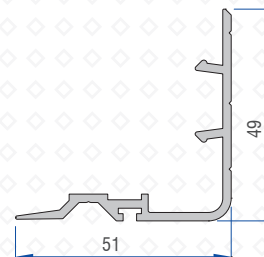

Mega Sash Cover Profile
41064-40300

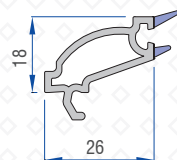

Single Glazing Bead (6mm)
41064-30100



Double Glazing Bead (24mm)
40101-04500

PROFILES

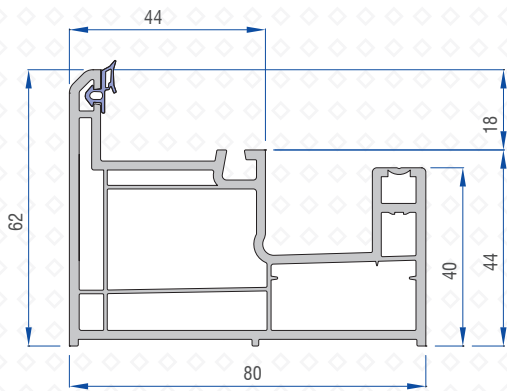

Mono Rail Profile
41164-10400

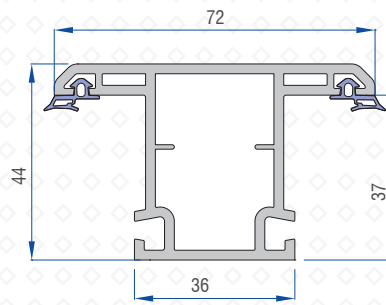

Mullion Profile
41164-20500

Aluminium Profiles

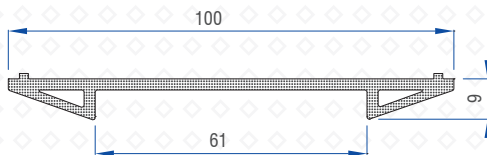

Casement Sliding Middle Coupler 2.5T (I-64)
50502-11063

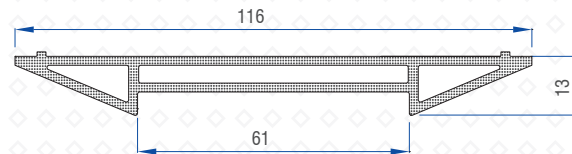

Casement Sliding Middle Coupler 3T (I-64)
50502-11064

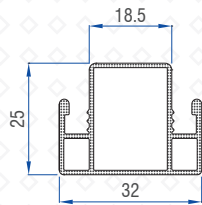

Screen Sash Mullion (Alm)
50502-11037

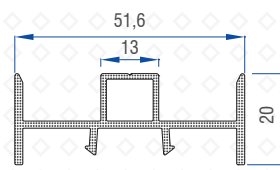

Inline Sash Adaptor (I-64)
50502-11065

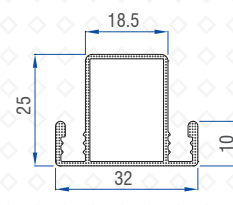

Mega Screen Sash Mullion-2.5T (Alm)
50502-11058

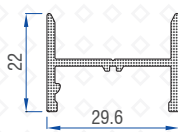

Adaptor for Screen Sash-2.5T (Alm)
50502-11048



Rail Profile (Alm)
50502-11011



Flat Rail Profile (Alm)
50502-11013

GA DRAWINGS - SLIDING WINDOW

2 TRACK 2 PANEL WINDOW

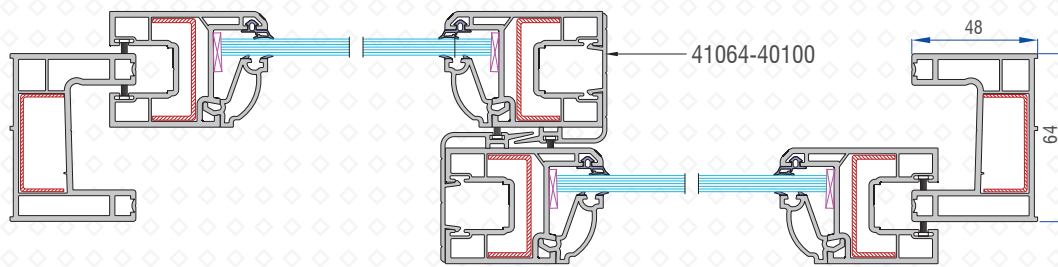
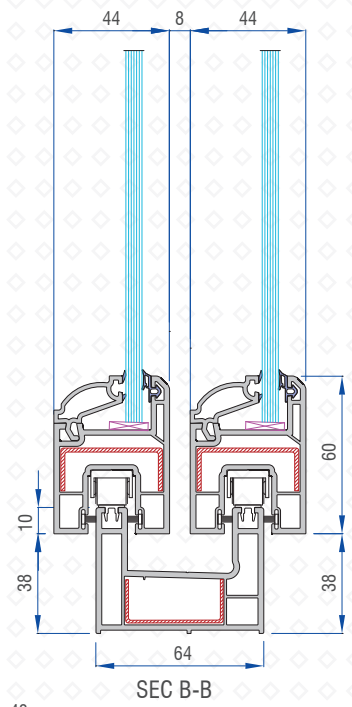
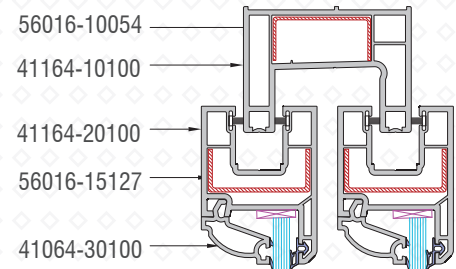
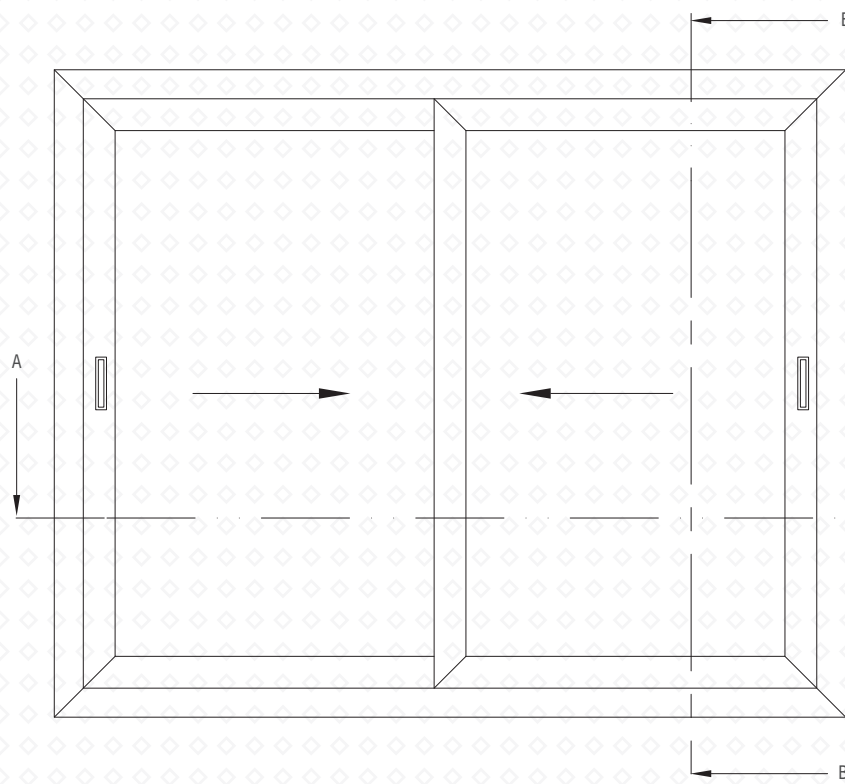

SEC A-A

41064-40100

2.5 TRACK 2 PANEL WITH MESH

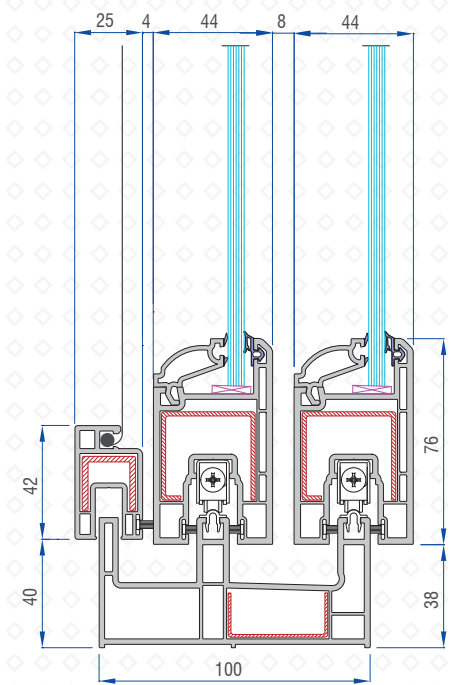
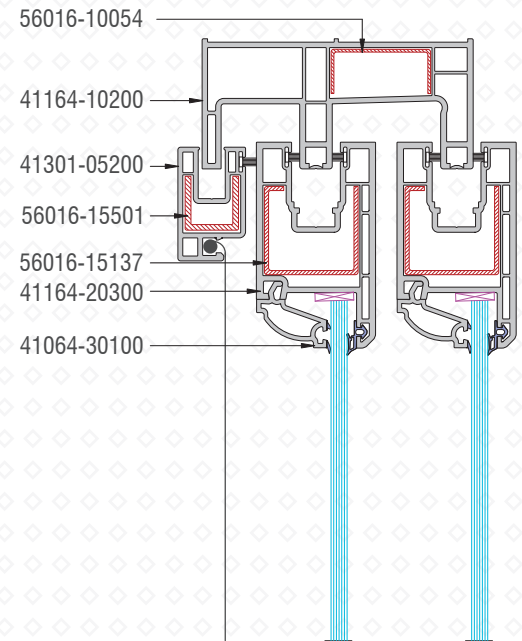
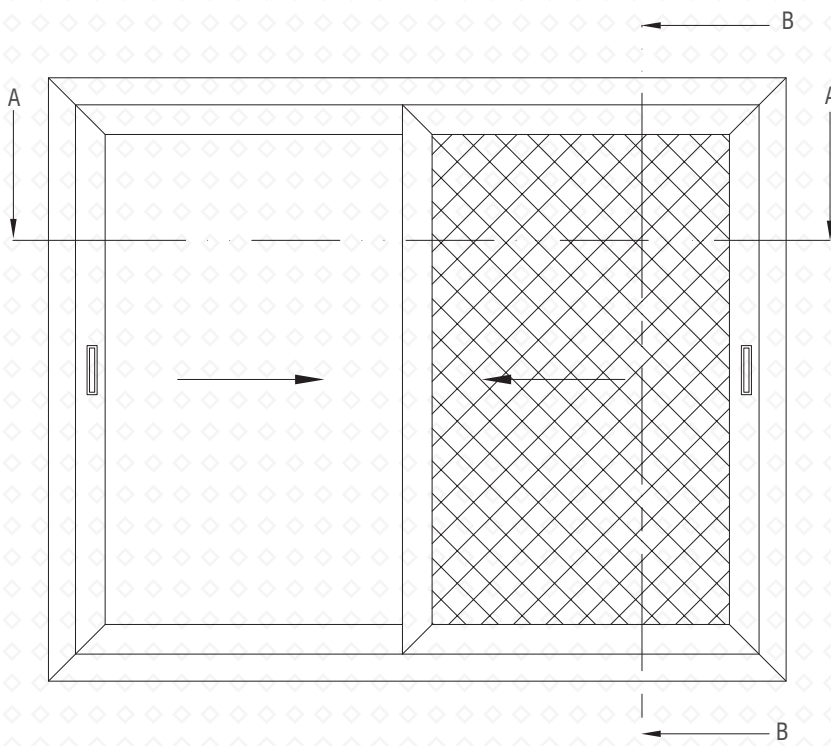

SEC B-B

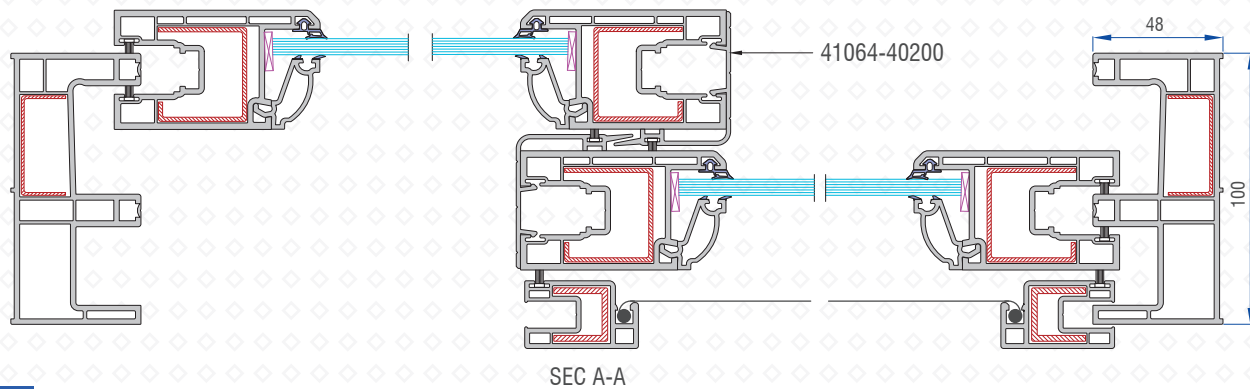

SEC A-A

3 TRACK 3 PANEL DOOR

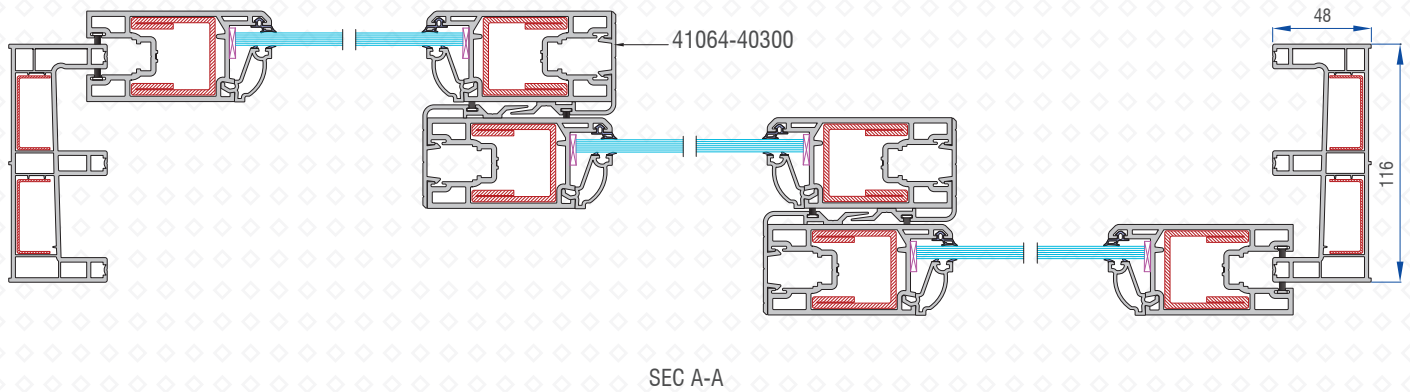
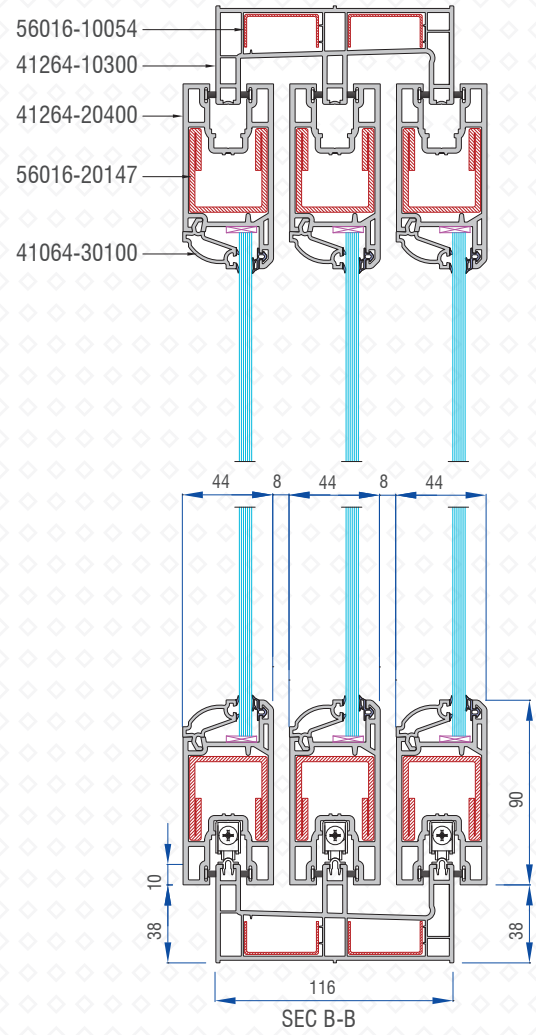
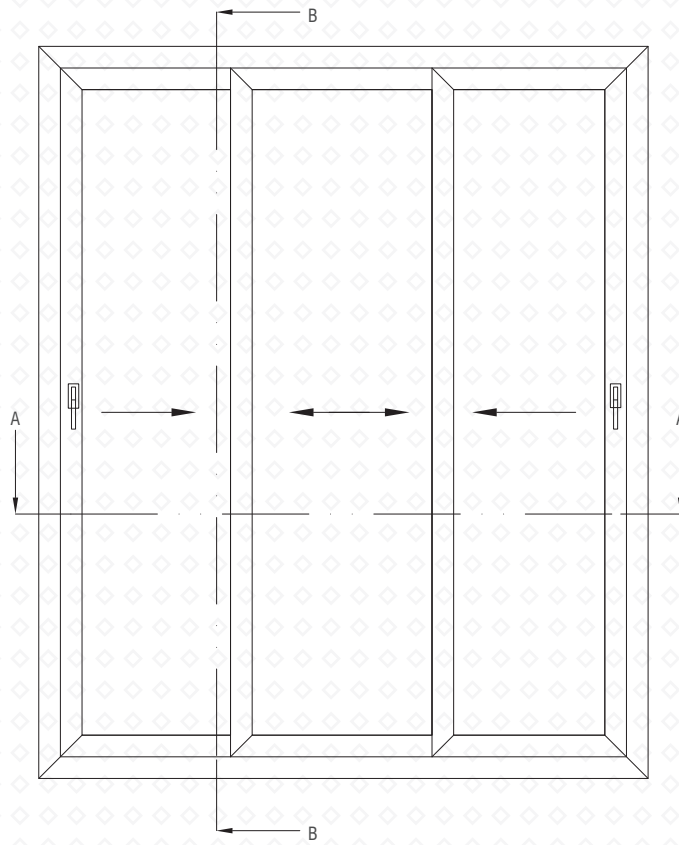

I - 75 SLIDING SERIES



LAMINATION COLOURS

Standard:



Mahogany



Rustic Oak



Golden Oak



Grey



Walnut



Black

PROFILES

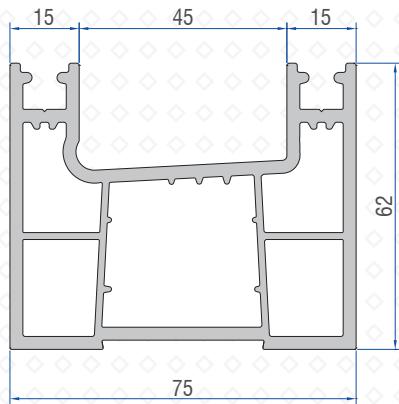

Double Rail Profile
41221-01000

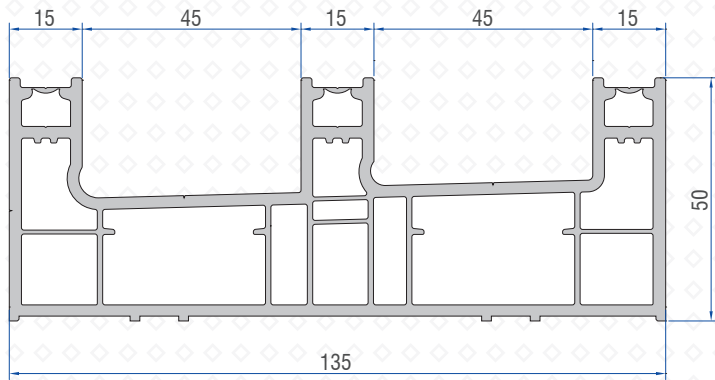

Triple Rail Profile
41221-02000

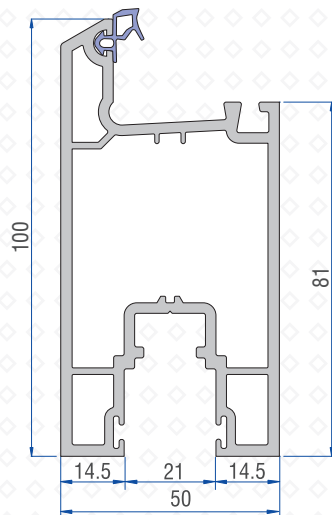

Mega Sash Profile (I-75)
41221-14000

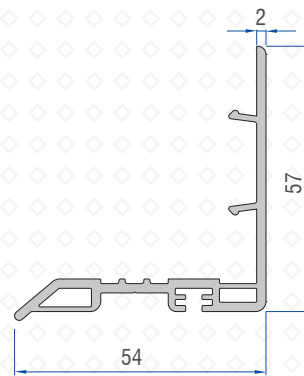

Mega Sash Cover Profile (New)
41221-07100

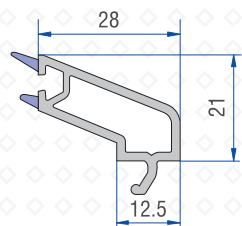

Single Glazing Bead (6mm)
40101-03200

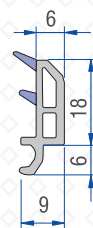

Double Glazing Bead (24mm)
40101-04500

PROFILES

Aluminium Profiles

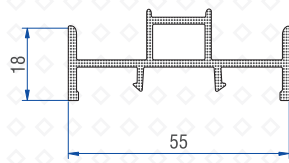

Inline Sash Adaptor (Alm)
50502-11035



Rail Profile (Alm)
50502-11014

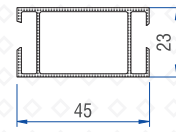

Multi track Adaptor (Alm)
50502-11031

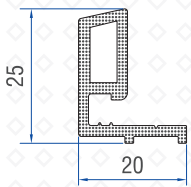

Mesh Adaptor (Alm)
50502-11041

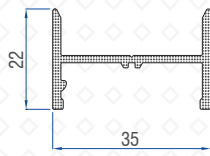

Adaptor for Super Screen Sash
50502-11049

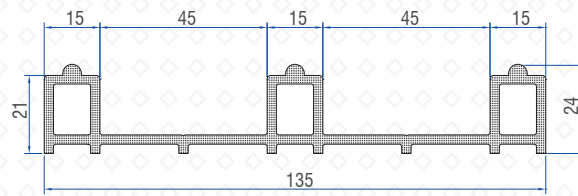

3-Track Low Threshold (I-75) Alm
50502-11069

GA DRAWINGS - SLIDING DOOR

2 TRACK 2 PANEL DOOR

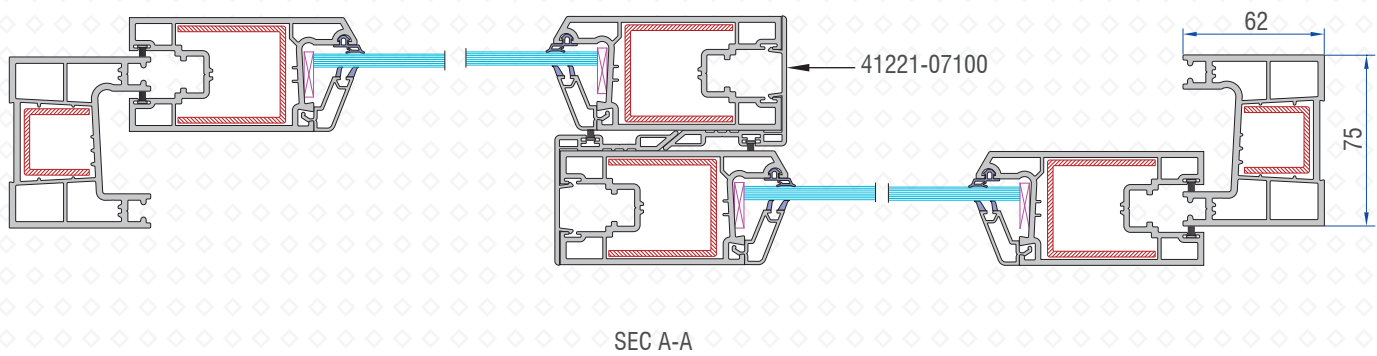
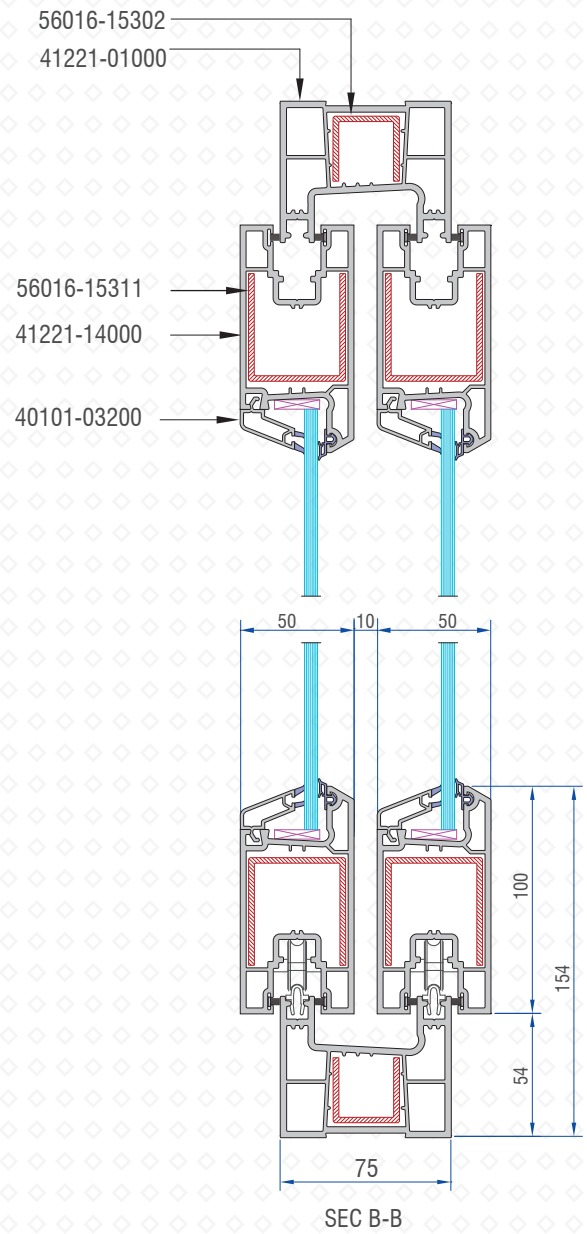
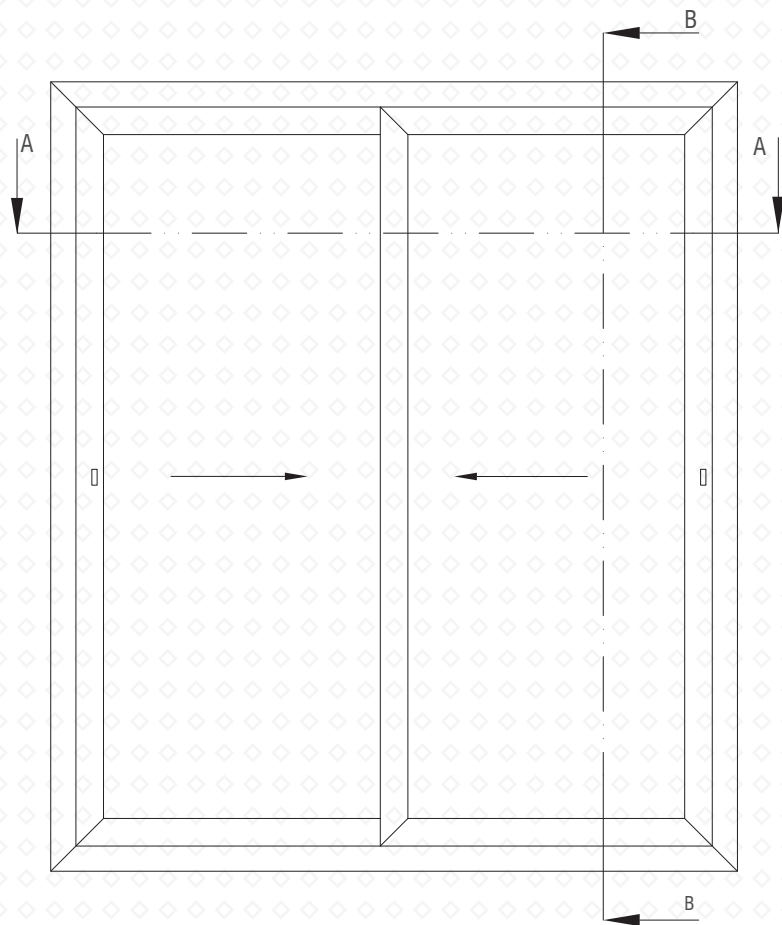

GA DRAWINGS - SLIDING DOOR

3 TRACK 3 PANEL SLIDING DOOR

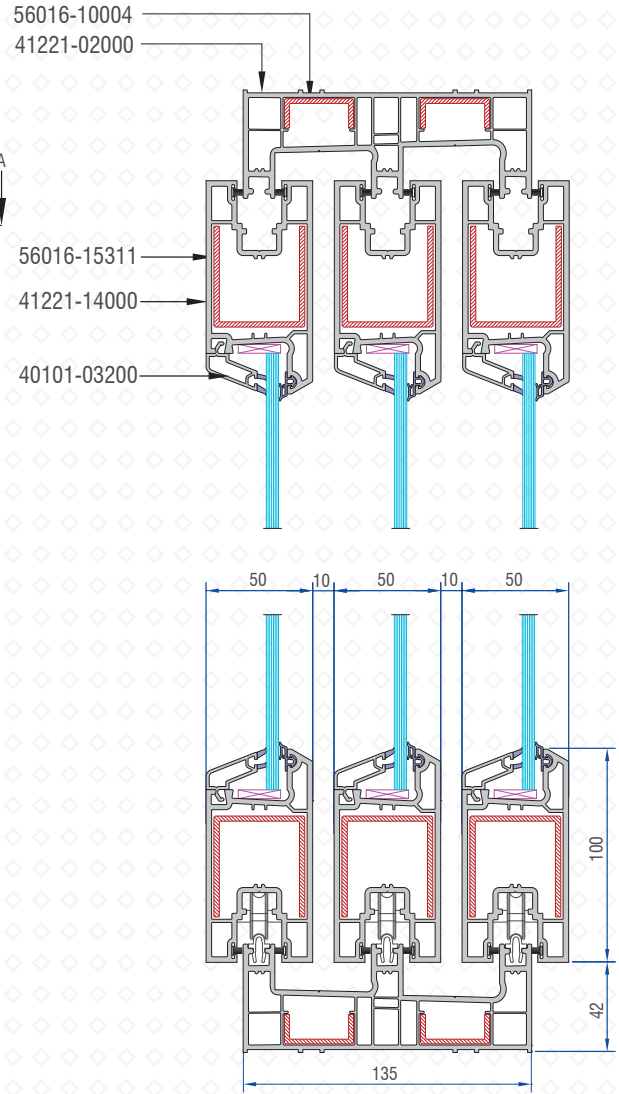
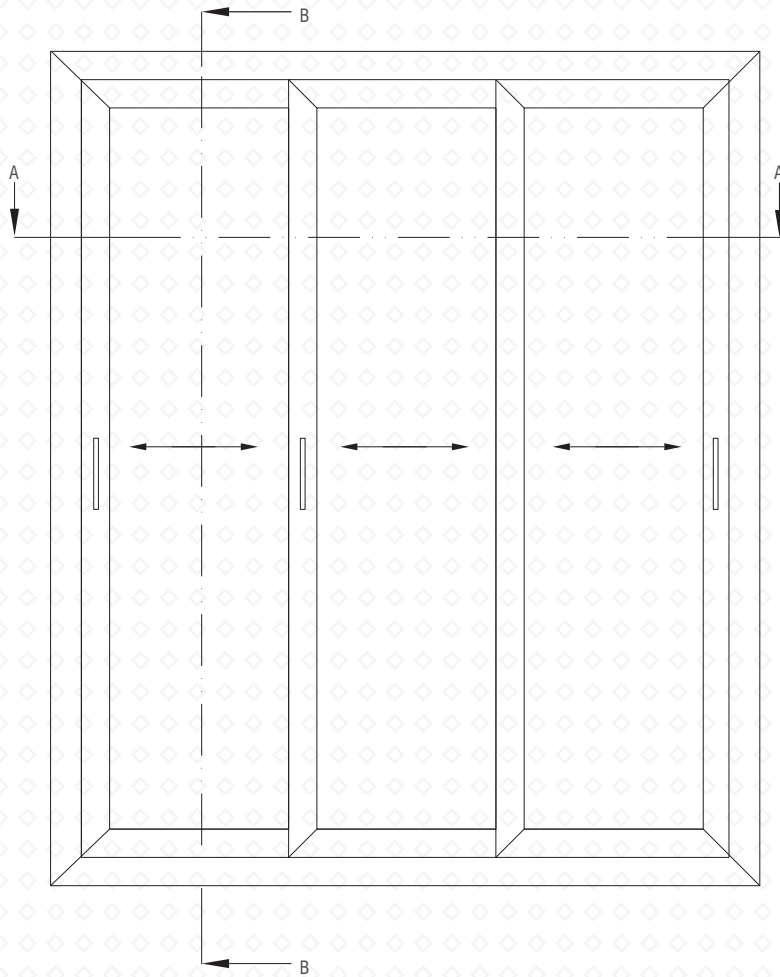

SEC B-B

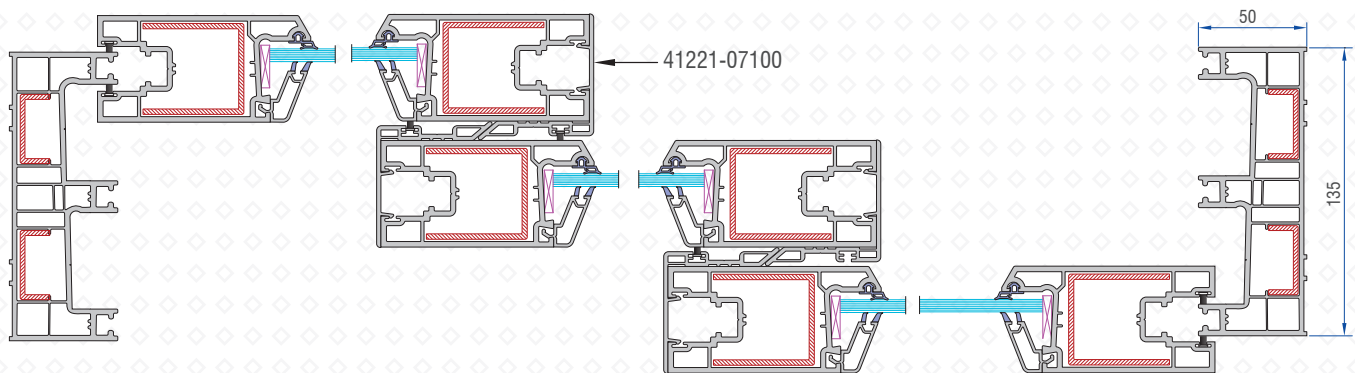

SEC A-A

GA DRAWINGS - SLIDING DOOR

3 TRACK 2 PANEL DOOR WITH MESH

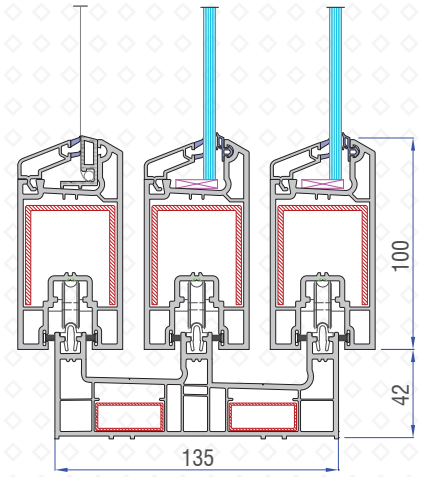
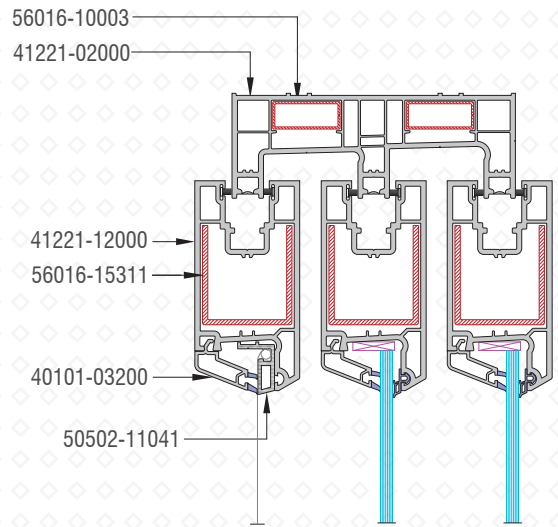
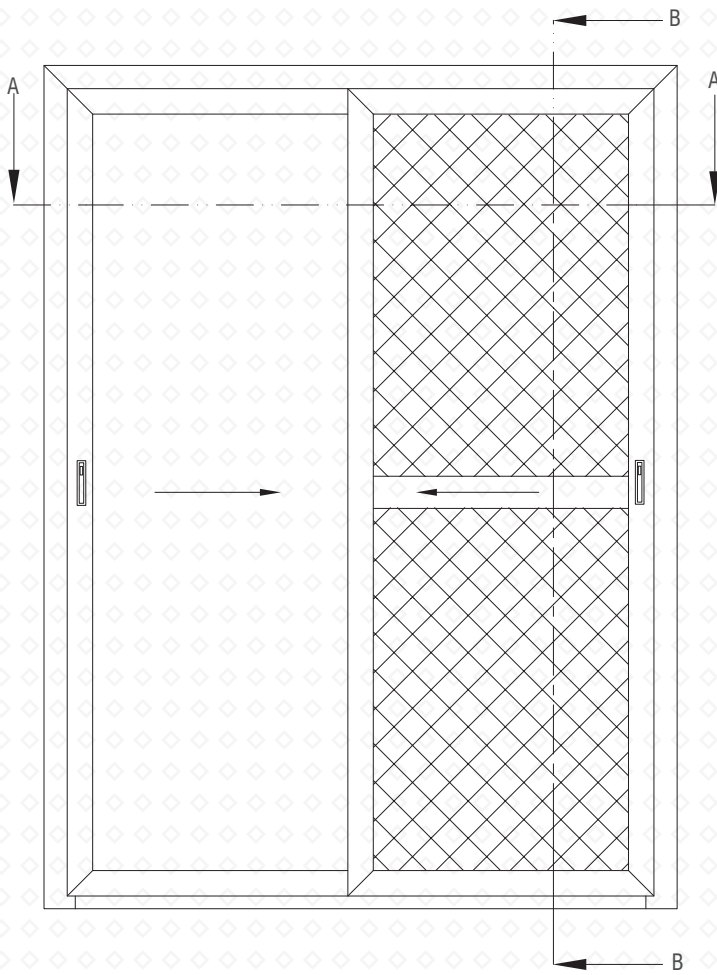

SEC B-B

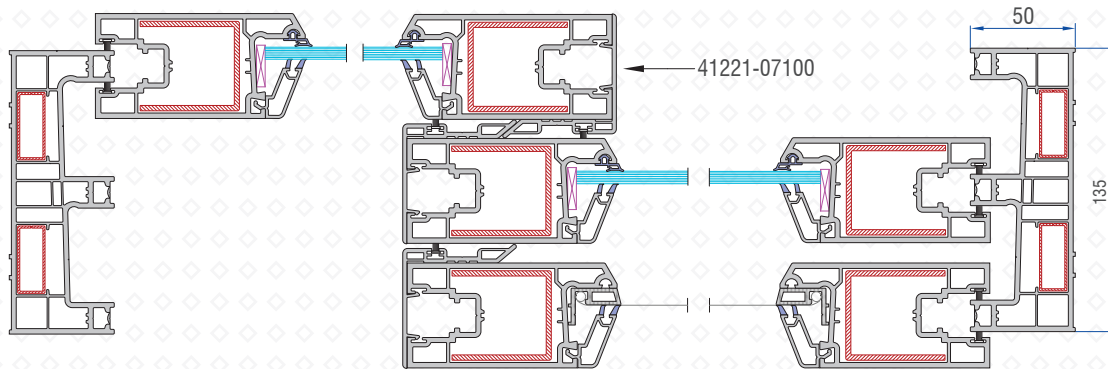

SEC A-A

I - 39 COMPACT CASEMENT SERIES



PROFILES

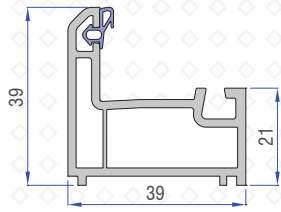

Compact Frame Profile
41101-17000

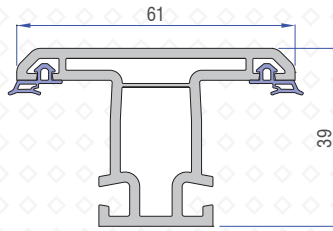

Sash/Mullion profile
41201-04000

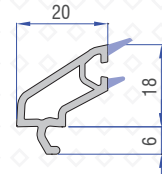

Single Glazing Bead (6mm)
40101-04400

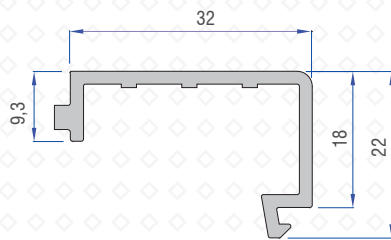

Louvre Clip
41101-18000

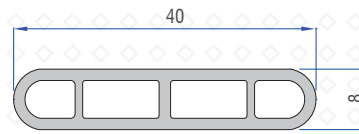

Louvre Blade
41101-18100

Aluminium Profiles

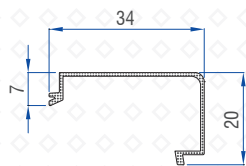

I-39 Louvre Clip(Alm)
50502-11056

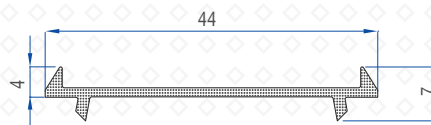

Frame Coupler(I-44 to I-39)
50502-11061

GA DRAWINGS - VENTILATOR

TOP HUNG WITH VENTILATOR

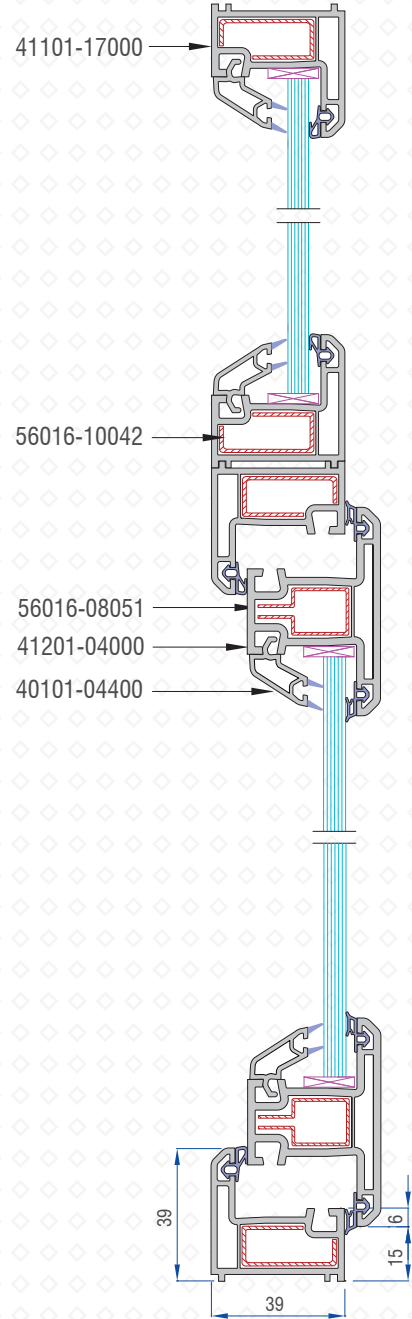
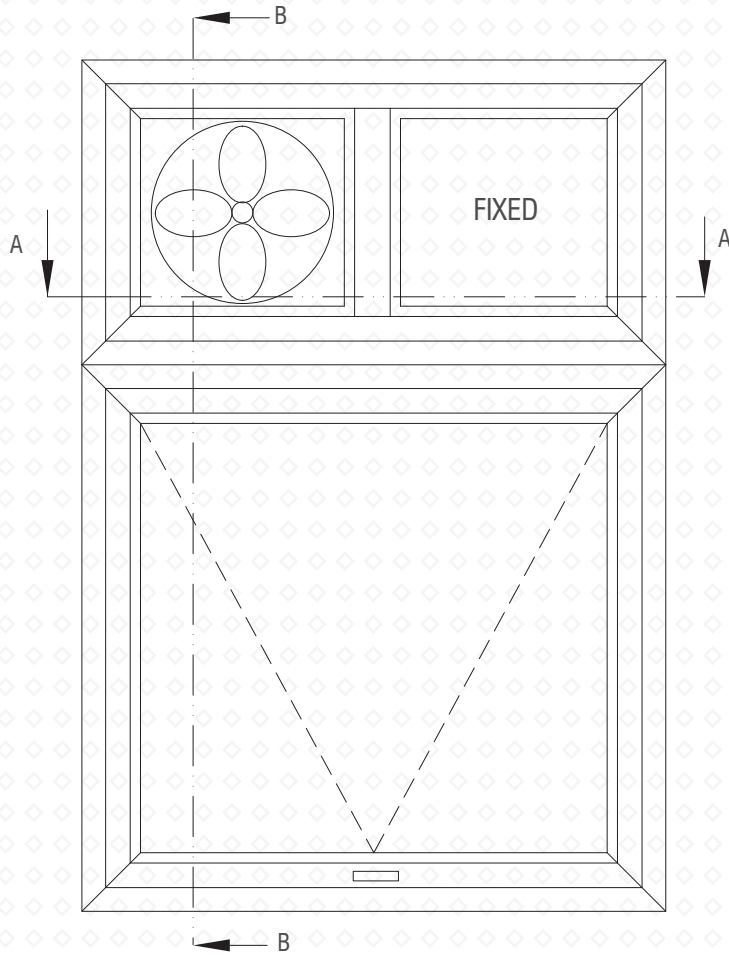

SEC B-B

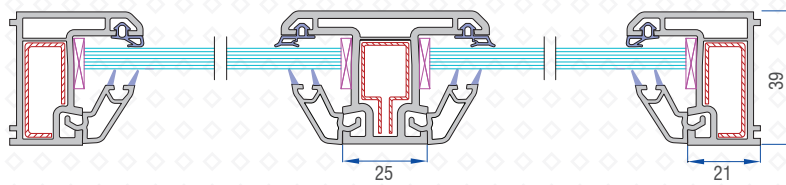

SEC A-A

GA DRAWINGS - CASEMENT FIXED LOUVER

CASEMENT FIXED LOUVER

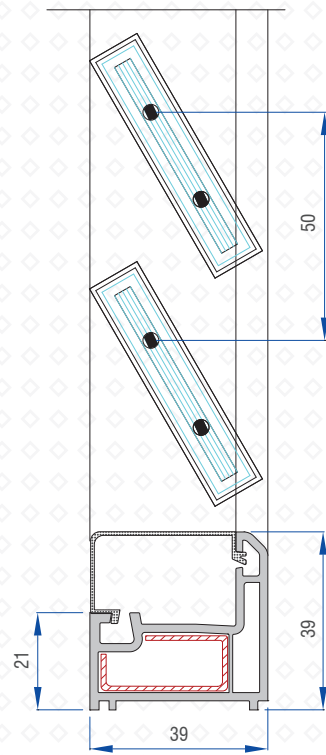
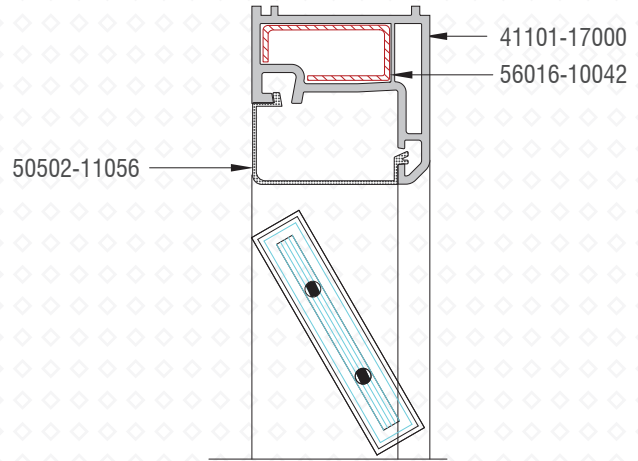
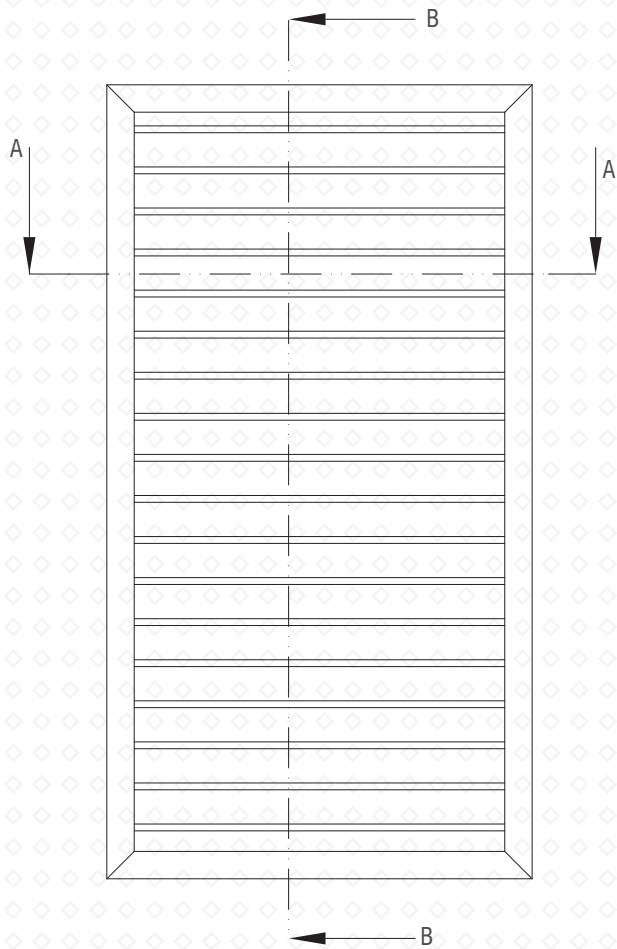

SEC B-B

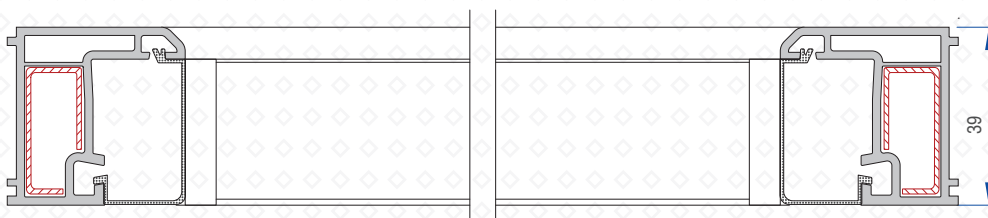

SEC A-A

I - 44 COMPACT SLIDING SERIES

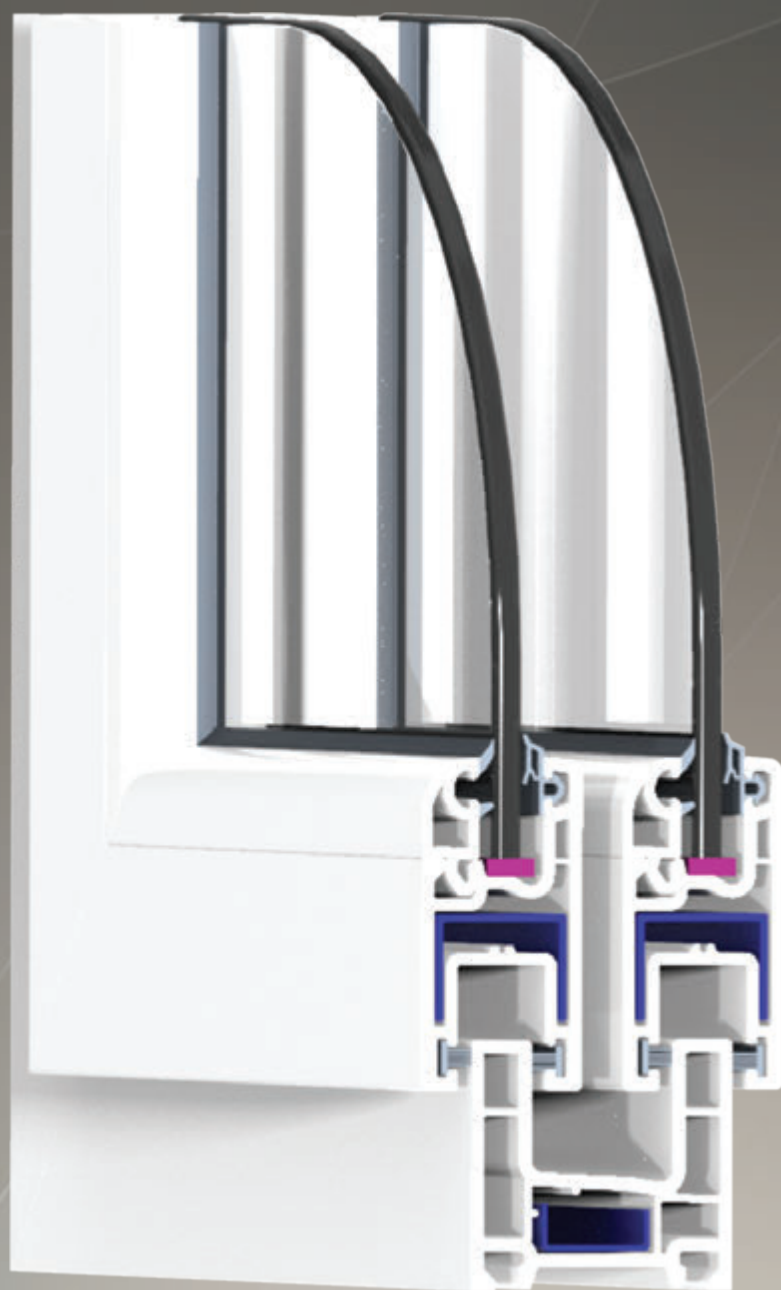

PROFILES

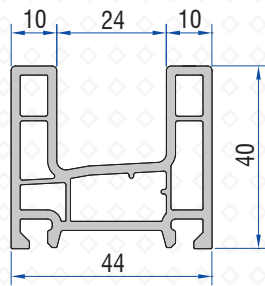

Double Rail Profile
41231-02000

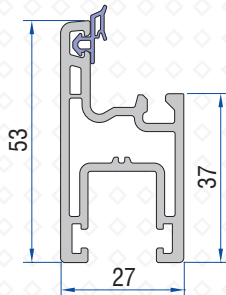

Sliding Sash
41231-13100

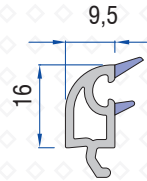

Single Glazing Bead
40502-14000

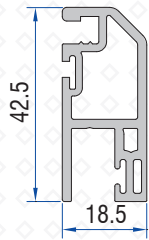

Adaptor Screen Sash
41301-05000

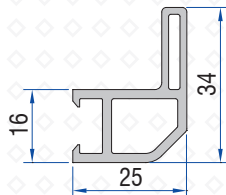

Screen Sash Adaptor
41301-05100

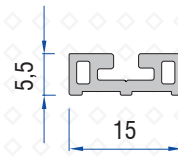

Lap Strip
41064-40400

Aluminium Profiles

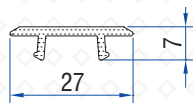

Sash Cover(Alm)
50502-11059

GA DRAWINGS - SLIDING WINDOW

2 TRACK 2 PANEL WINDOW

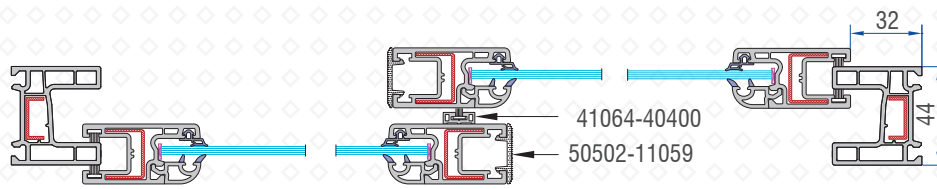
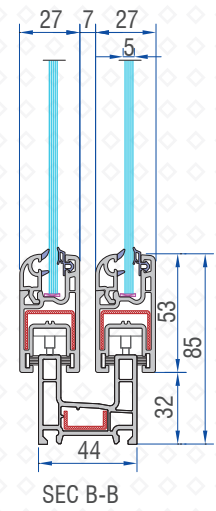
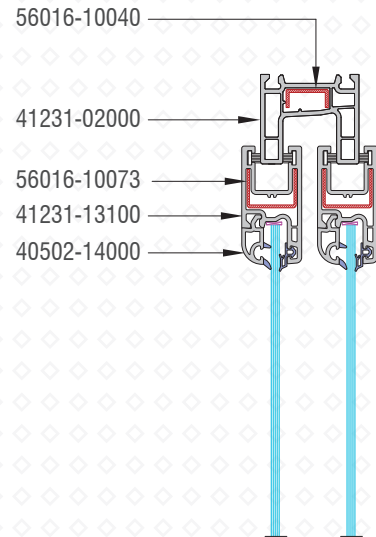
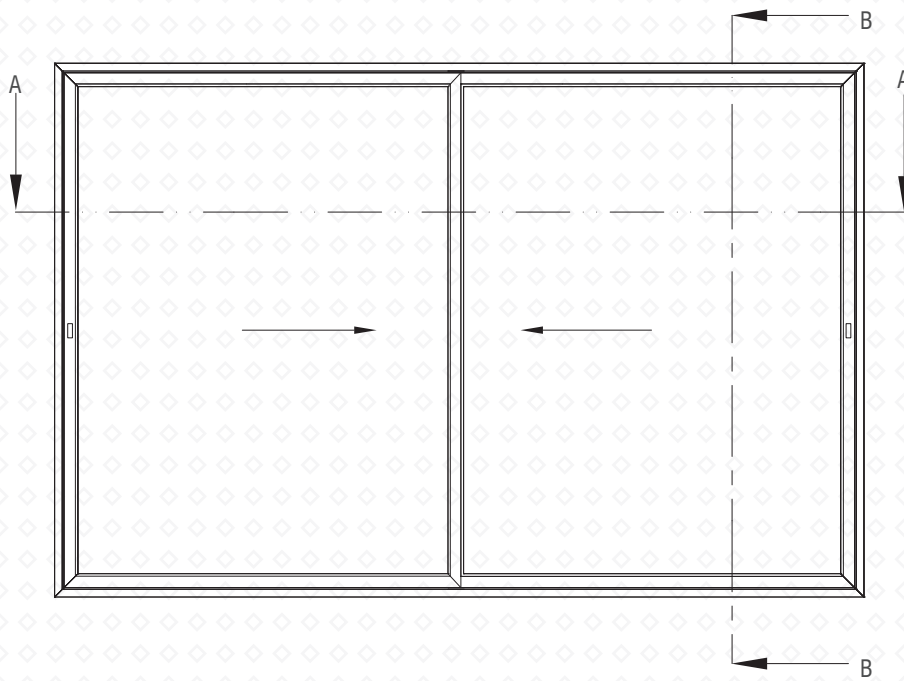

SEC A-A

GA DRAWINGS - SLIDING WINDOW

2 TRACK 2 PANEL WINDOW WITH MESH

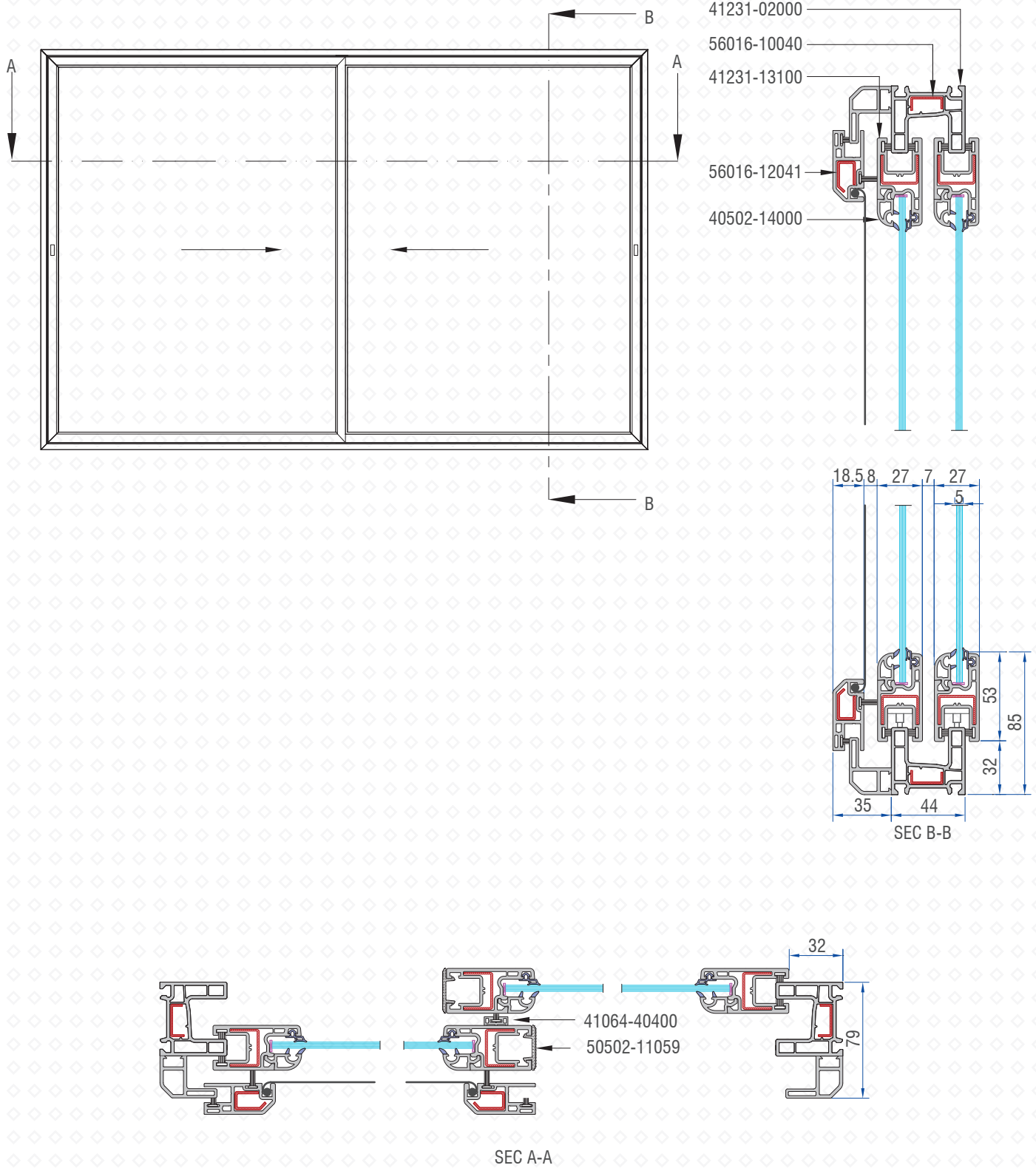

REINFORCEMENTS

I-60 CASEMENT SERIES

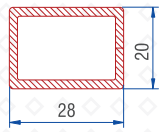

Frame / Mullion Reinf.
1.0mm : 56016-10001

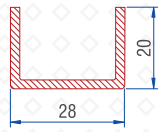

Frame / Mullion Reinf.
1.0mm : 56016-10002

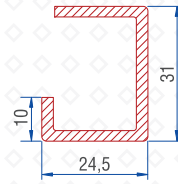

Window Sash Reinf.
1.5mm : 56016-15011

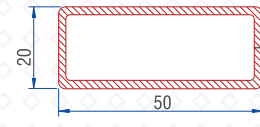

Large Coupling Reinf.
1.0mm : 56016-10010

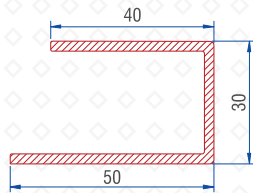

Door Sash Reinf.
1.5mm : 56016-15012



Lap Joint Reinf. / 135°
1.5mm : 56016-15008

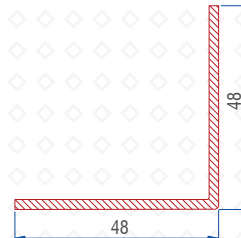

Corner Reinf. (90°)
1.0mm : 56016-10071

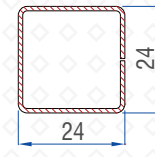

Grill Reinf. (New)
1.0mm : 56016-10044

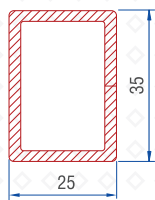

Grill Reinf.
2.0mm : 56016-20039

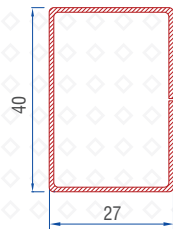

Super Frame Reinf.
1.0mm : 56016-10056

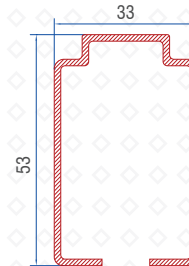

Stiffener Profile / Hurricane Bar Reinf.
2.0mm : 56016-20072

I-60 SLIDING SERIES

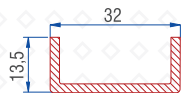

Double Rail / Triple Rail Reinf.
1.0mm : 56016-10004

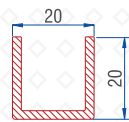

Screen Sash Reinf.
1.5mm : 56016-15501

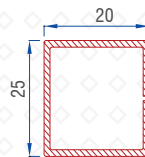

Mega Screen Sash Reinf. /
Super Screen Sash
1.5mm : 56016-15601

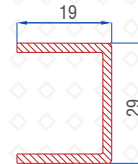

Sash Reinf.
1.5mm : 56016-15177

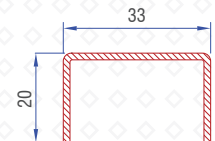

65mm Sash Reinforcement
1.5mm : 56016-15117

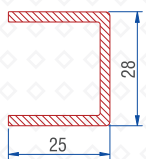

Super Sash Reinf.
1.5mm : 56016-15017

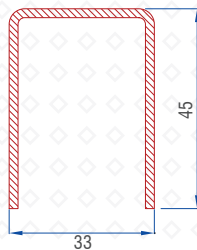

Mega Sash Reinf.
2.0mm : 56016-20047

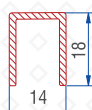

Mullion Reinf.
1.5mm : 56016-15006

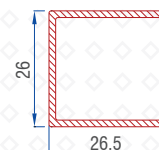

Mega Sash Reinf. (Secondary)
1.5mm : 56016-15057

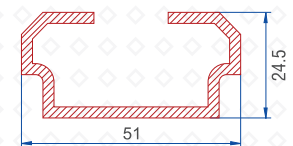

Hurricane Bar Reinf.
2.0mm : 56016-20020

NOTE: THE THICKNESS OF THE REINFORCEMENTS ARE INDICATIVE ONLY AND NEED TO BE OPTIMISED BASED ON SITE CONDITIONS AND WINDOW SPECIFICATIONS

REINFORCEMENTS

I-75 SLIDING SERIES

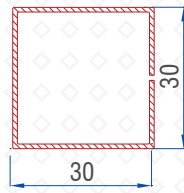

Double Rail Reinf.
1.0mm : 56016-10301

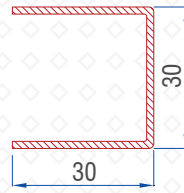

Double Rail Reinf.
1.0mm : 56016-10302

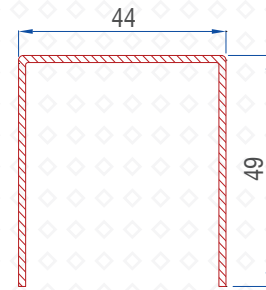

Mega Sash Reinf.
1.5mm : 56016-15311



Triple Rail Reinf.
1.0mm : 56016-10003



Triple Rail Reinf.
1.0mm : 56016-10004

I-39 CASEMENT SERIES

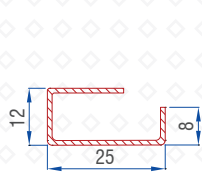

Compact Frame Reinf.
56016-10042

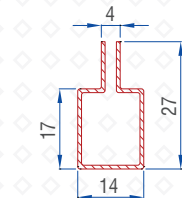

Sash/ Mullion Reinf.
56016-08051

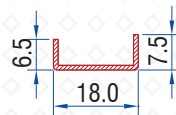

Frame Reinf.
1.0mm : 56016-10040

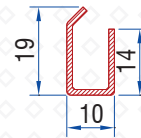

Adaptor Screen
Sash Reinf.
1.2mm : 56016-12041

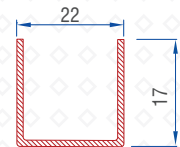

Sash Reinf.
1.0mm : 56016-10073

I-44 SLIDING SERIES

I-50 SLIDING SERIES

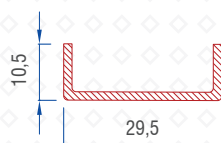

2T/2.5T Frame Reinf.
56016-10007

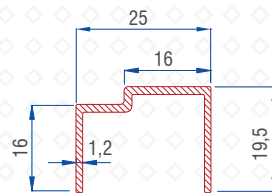

I-50 Sash Reinf.
56016-12107

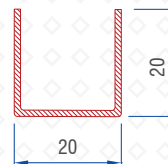

Screen Sash Reinf.
1.5mm : 56016-15501

I-64 SLIDING SERIES

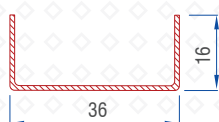

Double Rail / Triple Rail Reinf.
1.0 mm : 56016-10054



Sash Reinf.
1.5 mm : 56016-15127

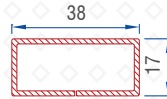

Mullion Reinf.
56016-15055

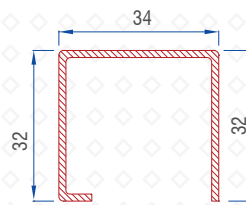

Super Sash Reinf.
1.5 mm : 56016-15137

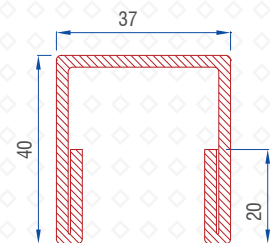

Mega Sash Reinf.
1.5 mm : 56016-15147

COMBINATION WINDOW USING CASEMENT SLIDING MULLION

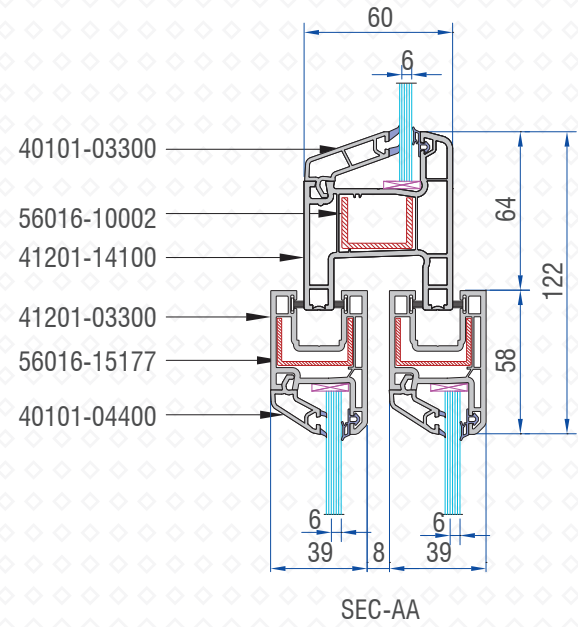
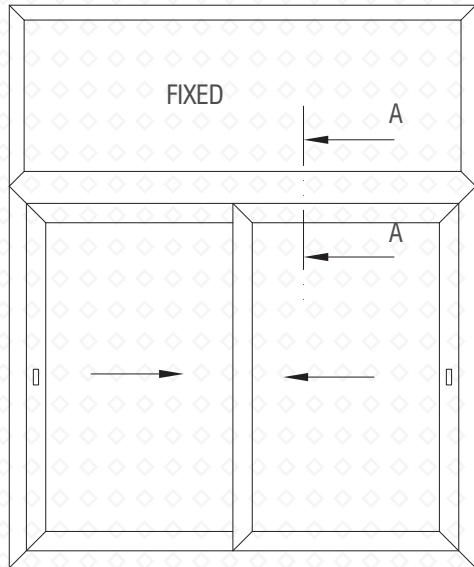

TRIPLE RAIL SLIDING DOOR WITH FIXED PANEL

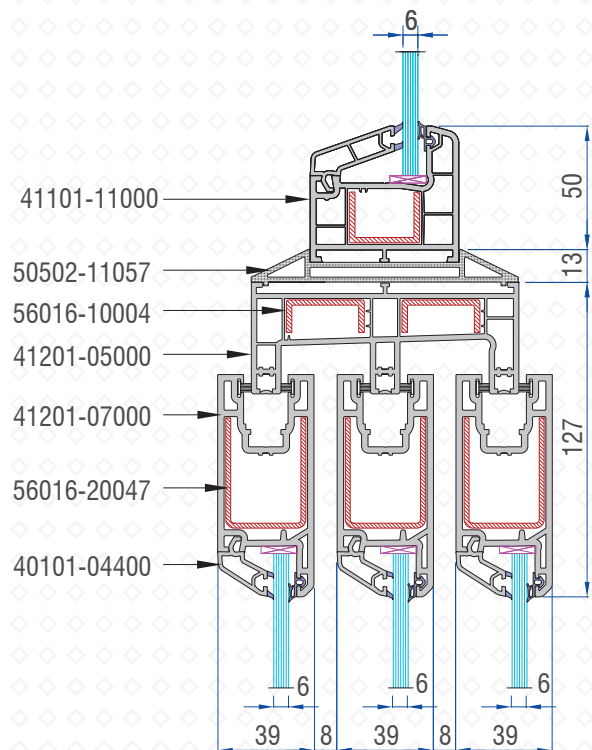
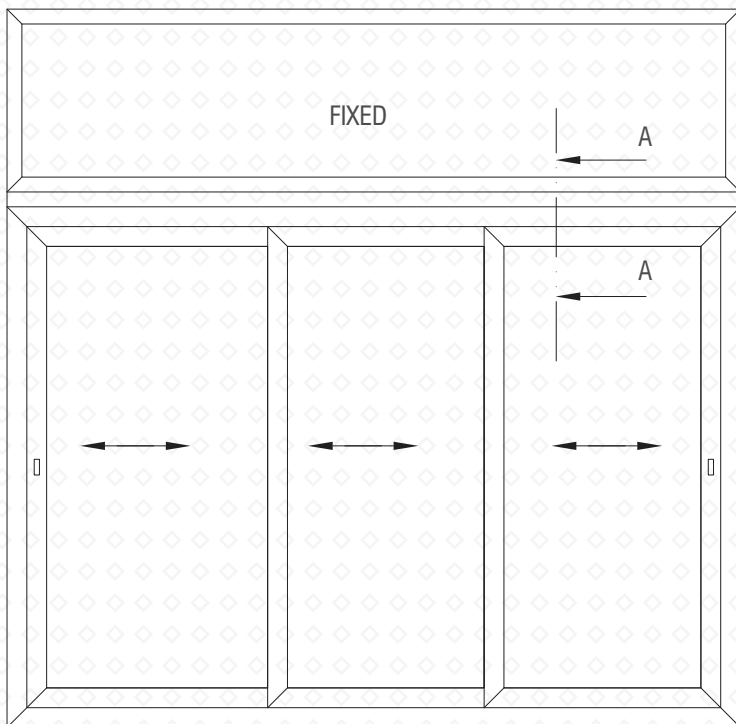

GA DRAWINGS - COMBINATION

SLIDING WINDOW WITH SCREEN AND FIXED PANEL

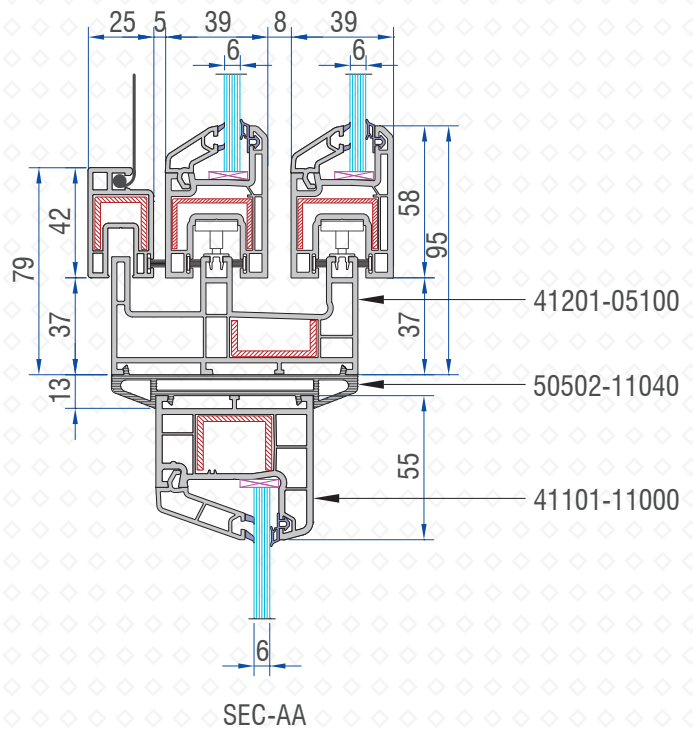
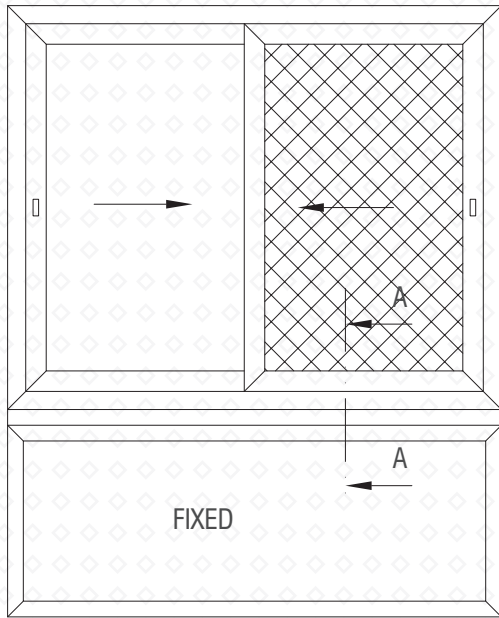

SLIDING WINDOW WITH SCREEN AND FIXED PANEL

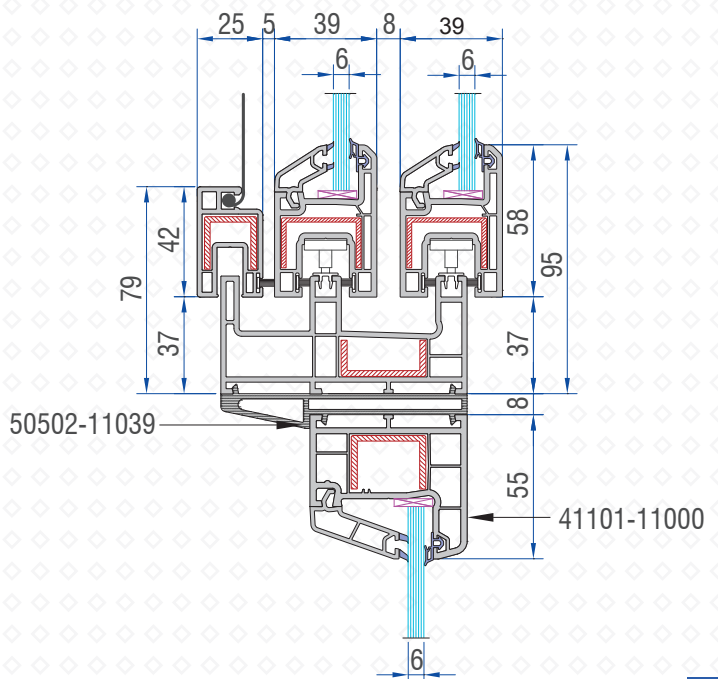
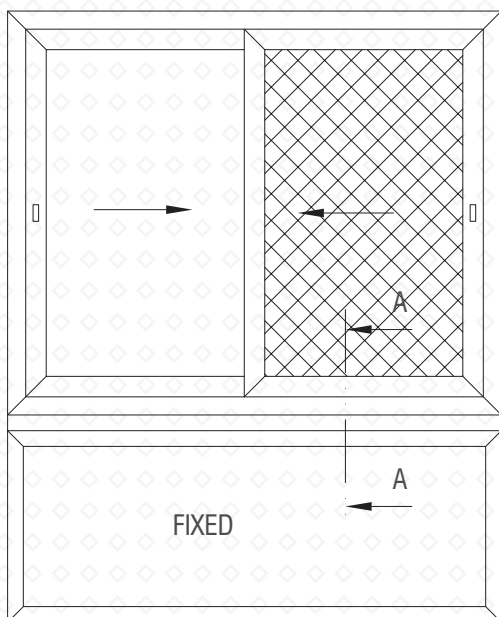

COUPLING JOINERY

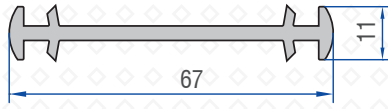

Mini Coupling
2108-3108

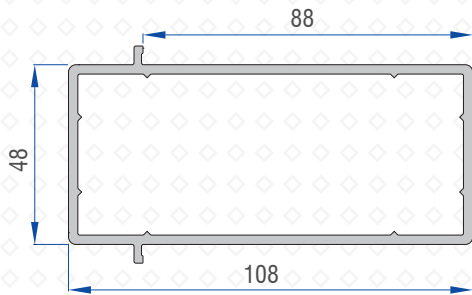

LARGE COUPLING PROFILE**
41165-30100G

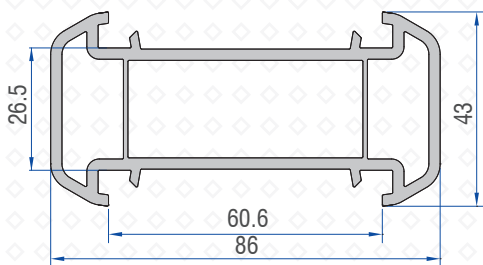

LARGE COUPLING PROFILE
40107 - 01200

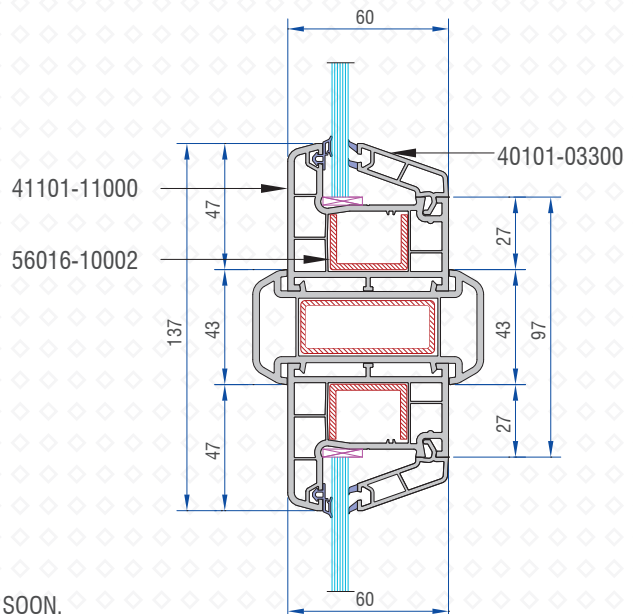
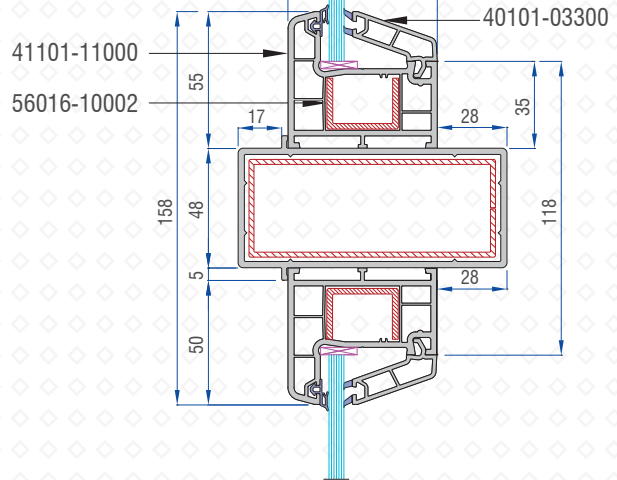
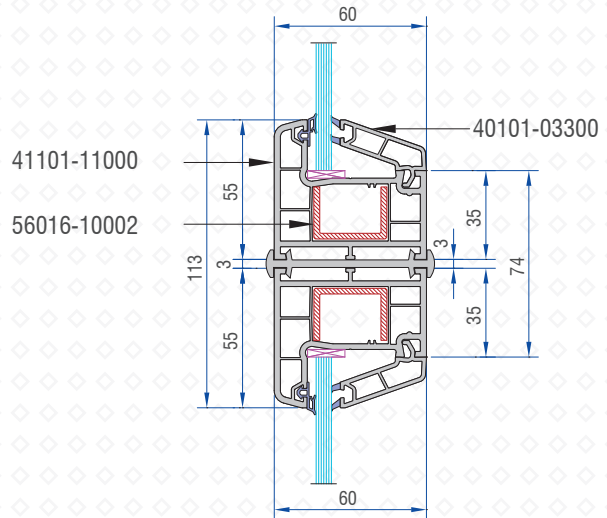

**NOTE : LARGE COUPLING PROFILE(41165-30100G) TO BE LAUNCHED SOON.

COUPLING JOINERY

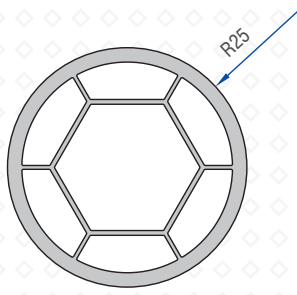
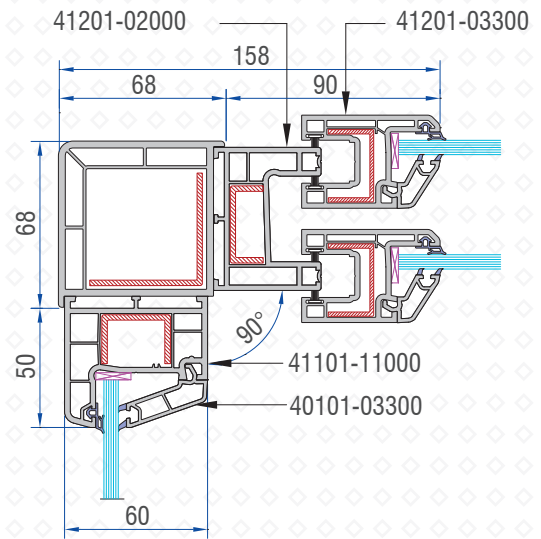
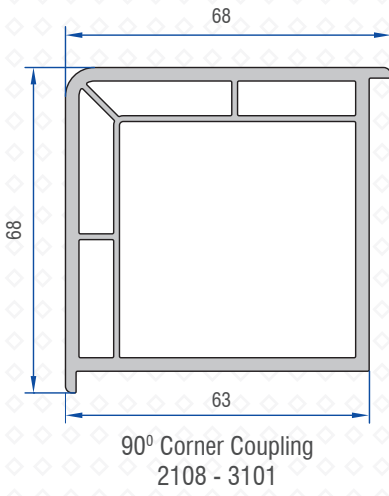

Bay Pole
2108-3103

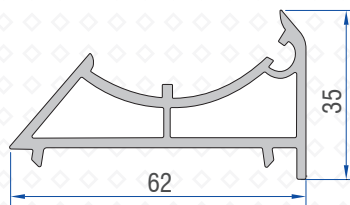

Bay Pole Adaptor
2108 - 3104

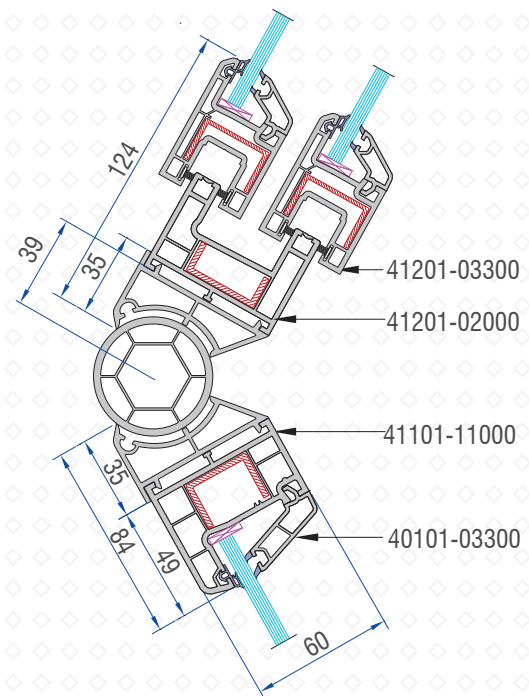

COUPLING JOINERY

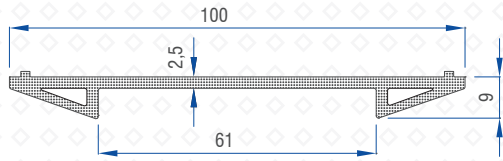

Casement Sliding Middle Coupler 2.5T (I-64)
50502 - 11063

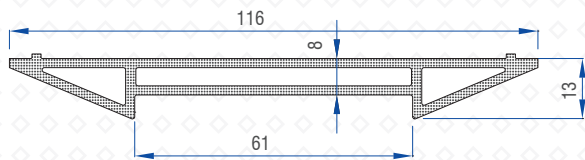
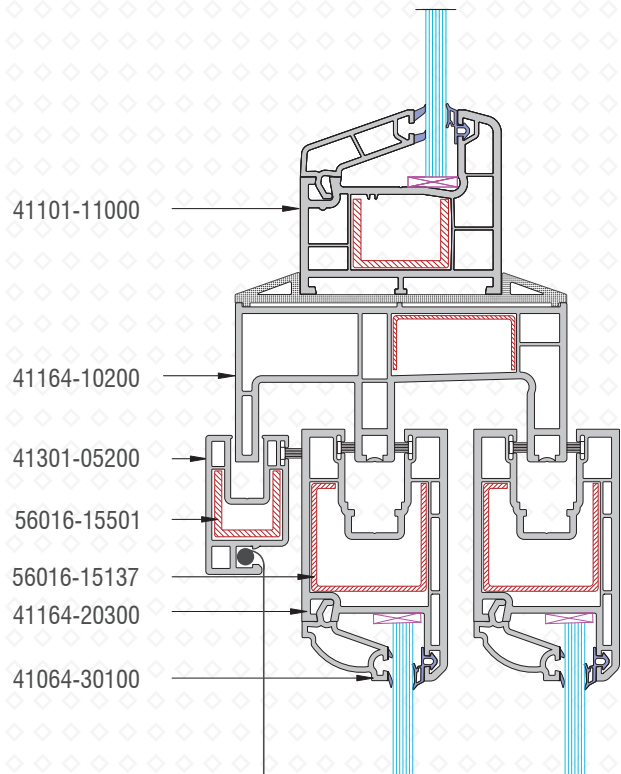

Casement Sliding Middle Coupler 3T (I-64)
50502 - 11064

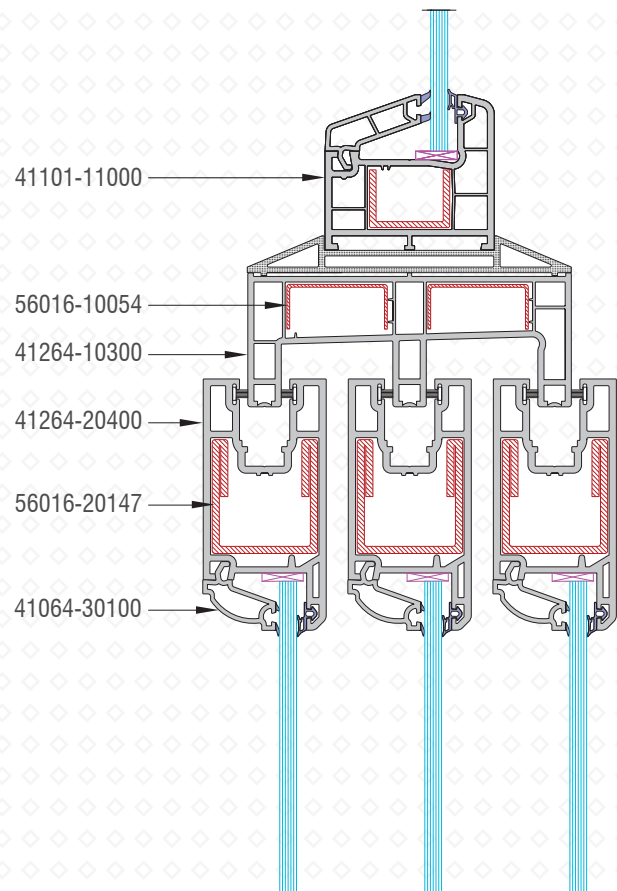

COUPLING JOINERY

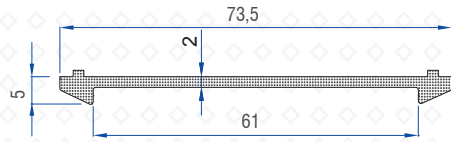

Frame Coupler I-60 Monorail to I-60
50502-11067

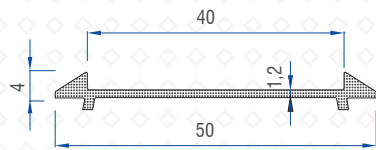
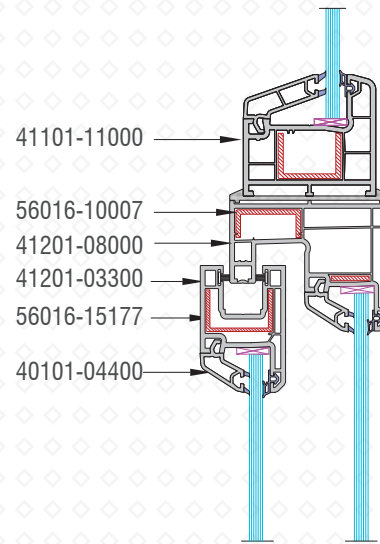

Frame Coupler I-50(2T) to I-39
50502-11066

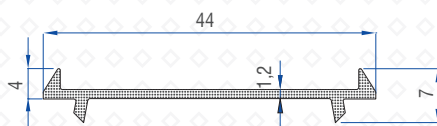
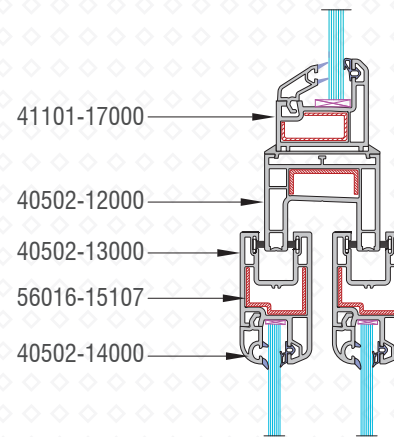

Frame Coupler (I-44 to I-39)
50502 - 11061

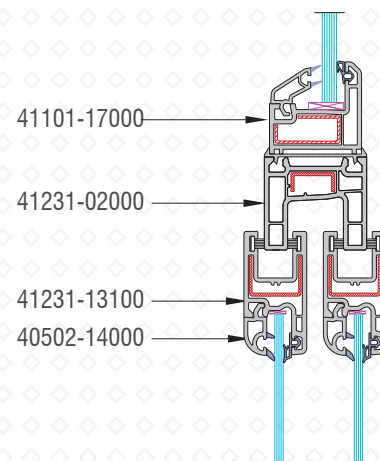

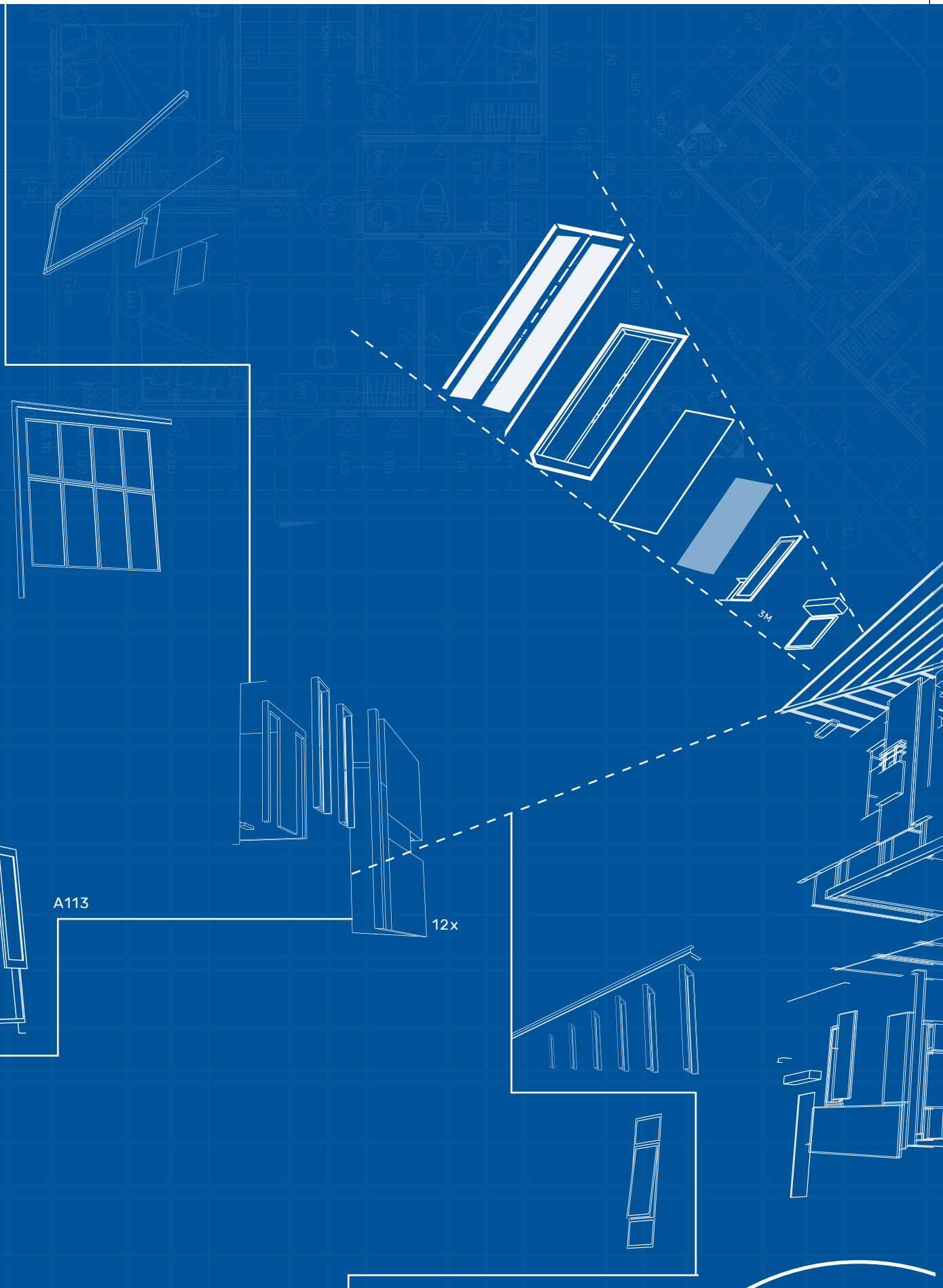

www.nclveka.com



NCL VEKA Limited
1st Floor, Fairfield by Marriott,
Gachibowli, Nanakramguda,
Hyderabad - 500 032.
T 040 6813 0000,
E contact@nclveka.com

